

University of Niš
Faculty of Mechanical Engineering

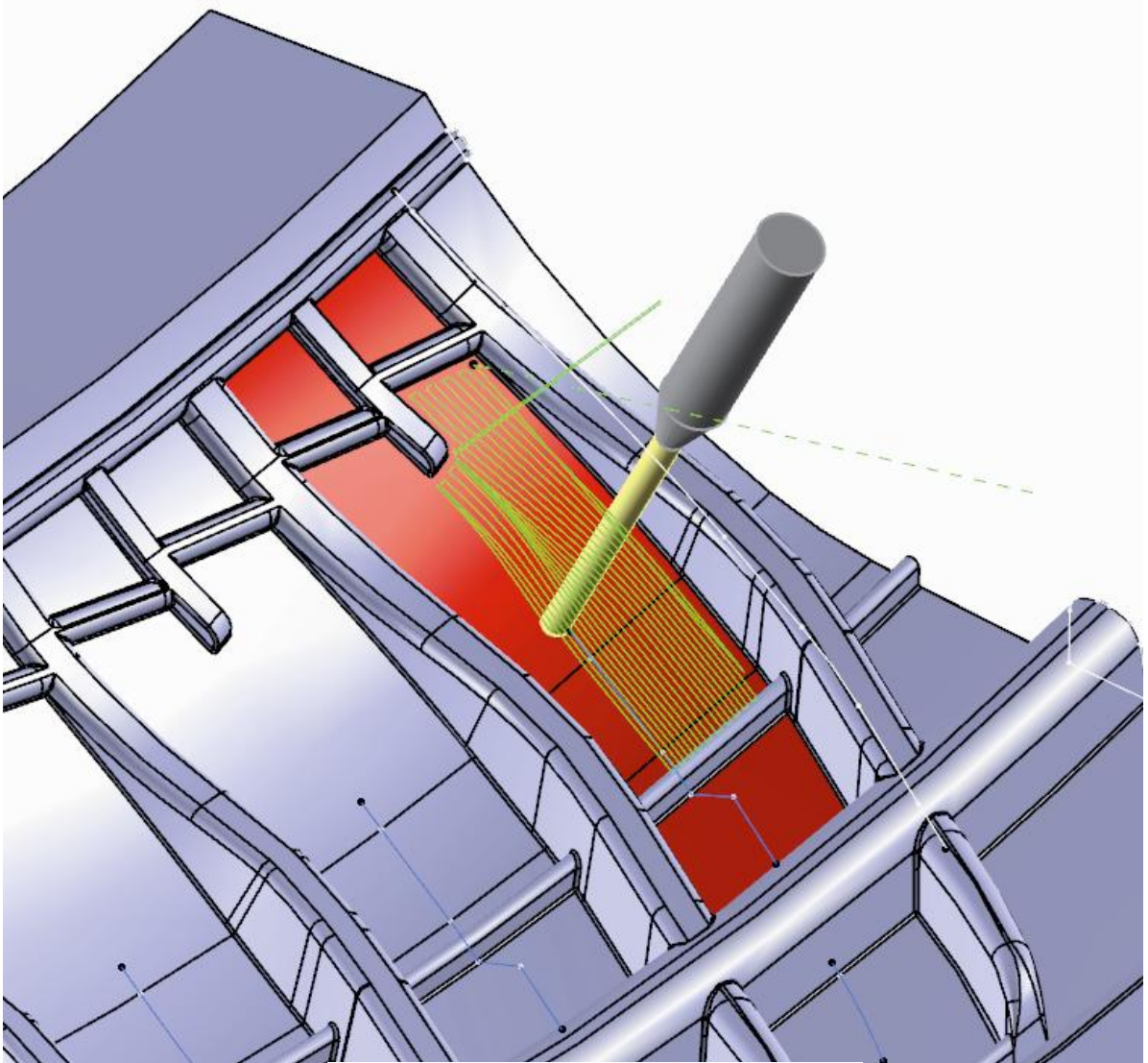

DEPARTMENT FOR PRODUCTION, IT AND MANAGEMENT



Editor:

Prof. Velibor Marinković
Faculty of Mechanical Engineering
University of Niš

Design:

Milan Trifunović, dipl.ing.
Faculty of Mechanical Engineering
University of Niš

Publisher:

Department for Production, IT and Management
Faculty of Mechanical Engineering
University of Niš

Edition:

Second

Circulation:

Year:

2012.

Electronic version:

2.0 (24.10.2012.)

Preface

Department for Production, IT and Management was founded in 1966 as Department for Machining and Machine Tools. Its founder and longtime chairman, professor Predrag Popović, has not only defined and expanded the science fields of department, but from the very beginning he has worked on the development of its human resources potential, so the department soon got its current name.

In the first years of its work the Department has been recognized in the region and beyond by advances in processing by forming. Owing to the research conducted by Vojislav Stoiljković, Velibor Marinković and Dragan Domazet, the Department has become regional lider in this field during the 1970s. With the arrival of Professor Aleksandar Pavlović members of the Department began to engage seriously in designing machine tools for processing by forming and processing by metal cutting, as well as using computers for analyzing their behavior and management. In the 1980s, Professor Dragan Domazet initiates the establishment of the Computer Center of Faculty of Mechanical Engineering in Niš, which created conditions for more serious research in this field, as well as for the research in the field of computer-aided design. The years of transition and fragmentation of manufacturing organizations have imposed the need that production engineering engineers have extensive knowledge in management. Taking this into account, the Department introduced a number of new subjects in the field of information technology, as well as in management and changes its name to Department for Production, IT and Management.

Following the accreditation of Faculty in 2009, new curricula are implemented on Department for Production, IT and Management (bachelor studies, master studies and doctoral studies), which are based on the principles of the Bologna Declaration. Accordingly, the process of education involves teaching, training, laboratory work, consultations, pre-exam duties (projects, term papers and colloquia) and professional practice. One-semester courses have been introduced:

- required, which provide basic knowledge in certain fields of science and
- electives, which provide specific knowledge and skills.

In late 2012, the Department for Production, IT and Management has reached a number of 19 members, of which 6 full professors, 2 associate professors, 4 assistant professors and 7 assistants. This kind of academic personnel has allowed the Department to work parallel on several national and international projects, as well as on the projects for the economy.

Having in mind the ongoing globalization in all spheres of social and business life and the need for local and global networking, Department for Production, IT and Management has decided to issue this publication in order to provide the interested parties with more information about the potential of the Department. The brochure contains general information about the Department, on its members, their teaching and scholarly work, projects and publications. Given the dynamics of the facts published in this brochure, the Department will periodically update the electronic version of the brochure that can be found on the following website: <http://www.masfak.ni.ac.rs/sitegenius/topic.php?id=16> .

October, 2012.

The chairman of the Department
Prof. Miroslav Trajanović

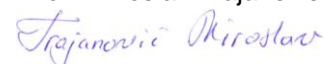

INSTITUTIONS

... even when the individual believes that science contributes to the human ends which he has at heart, his belief needs a continual scanning and re-evaluation which is only partly possible. For the individual scientist, even the partial appraisal of the liaison between the man and the historical process requires an imaginative forward glance at history which is difficult, exacting, and only limitedly achievable... We must always exert the full strength of our imagination.

Norbert Wiener

UNIVERSITY OF NIŠ

Univerzitetski trg 2

18000 Niš

Rectorate:

Tel.: +381 18 257 970

Fax: +381 18 257 950

www.ni.ac.rs

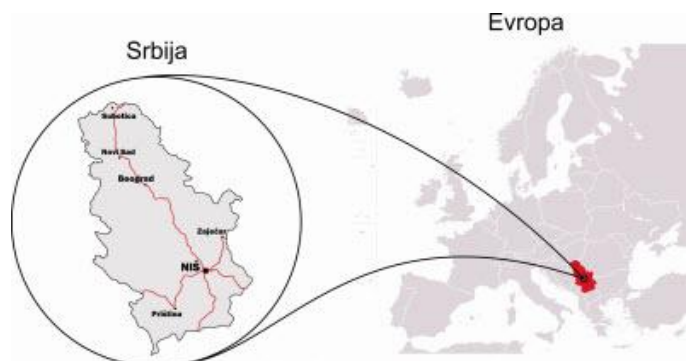

Niš - **Univerzitet**
Mašinski fakultet

FACULTY OF MECHANICAL ENGINEERING

Aleksandra Medvedeva 14

18000 Niš

Deanery:

Tel.: +381 18 588 255

Fax: +381 18 588 244

www.masfak.ni.ac.rs



CITY OF NIŠ

City of Niš, one of the oldest cities in the Balkans, is located on the crossroads of the major transportation routes linking Europe with the Middle East and has always been considered the „gate“ between East and West. Niš is situated in the Nišava Valley, near the place where it joins the Južna Morava river. There is a legend about the formation of the city, saying that the Prince of Niš built it with the stone from the nearby Hum's Hill. There are certain proofs that Niš was populated even in the prehistoric times. Geographer Ptolemy first time mentions this settlement in 140 BC. There are artifacts exposed in the Archaeological Museum in Niš that date back from the Neolithic and early Bronze Age (4000 BC).



The town was named after the river Nišava, which the Celtic ancient inhabitants called Navissos, and the Romans Naissus. As a powerful and invincible castrum in ancient times, Naissus has become an important strategic point since the second century. Constantine the Great (Flavius Valerius Constantinus), Roman emperor (306-337), successor of Diocletian, was born in Naissus in 274. AD, and he gave the city some of its most lavishing buildings (Mediana) and made it an important economical, military and administrative centre. By signing the Edict of Milan in 313. AD, Constantin the Great proclaimed Christianity the official religion in the state.

Although Niš was considered unconquerable city, in its long history it has been repeatedly conquered, destroyed and burned by Huns, Avars, Hungarians, Bulgarians and Turks. With the fall of Niš under the rule of Sultan Murad in 1385. the fate of Serbia was sealed for many centuries to come. The only significant building dating back from that period that has been preserved until today is Niš's Fortress, which was built in 1723.

For a long time of slavery under the Turks there were numerous uprisals, but without much success. The first significant attempt at the liberation of Niš from Turkish rule was the First Serbian Uprising, which happened on May 31, 1809, when the rebels under the command of the Duke Stevan Sinđelić clashed with the superior Turkish army near Čegar. Instead of the surrender, Serbian rebels chose dignified death. Stevan Sinđelić blew up the Čegar's trench by firing at the warehouse of gunpowder. In order to „folk“ remembers the defeat, Huršid Pasha built the Skull Tower of skulls of Serbian heroes near the Constantinople road, which is a unique monument in the world. The first mark where Battle of Čegar Hill took place was built on July 4, 1878.

Niš was not released until the second Serbian-Turkish war, on January 11, 1878, when prince Milan Obrenović entered Niš's fortress after long and difficult struggles. By the decision of Congress of Berlin on July 13. 1878 Serbian state was comprised of the districts of Niš, Pirot, Topola and Vranje. Since then, Niš has been rapidly developing in economical, cultural and political sphere.

Right after the liberation of Niš from the Turks, it became the center of the Authority of the Church – Metropolitane and Eparchy of Niš. During the same year, the first high school was opened, with 48 students in the first grade. On March 1, 1878, elementary schools for male and female students were opened, with total of 607 pupils. The year 1879. is remembered as a year when National library was founded. Teacher's Training School began working in 1881, with 31 pupils in the first grade. In that same year the first bank in Niš was opened. In 1884, a new railroad was built, connecting Niš with Belgrade and becoming the key factor for development in economy and trade in this part of Serbia. In



the same year the Railroad Stakehold (workshop) was founded – it became the first and the biggest company in the city, and the first local newspapers were published - "Niški vesnik". During that time, other companies in the city started working, some of them being: Brewery (1884), Tobacco factory (1885), Brickyard (1885), and, some time later, Printing (1901), Rolling mill (1903), Hydropower "Sveta Petka" on the river Nišava in Sićevo Gorge (1908). On March 11, 1887, the first theatre, "Sinđelić", was founded. Near the river Nišava, in Belgrade-mahala in 1889 the County Administration Building was built ("Banovina"). Right after the liberation of Niš from the Turks the first health facility started

working – Big military hospital in Niš. It should be mentioned that, after the liberation, Niš did not have a single doctor. The first civil hospital in Niš was founded in 1881. A special place in history of Niš's health institutions is a moment when Pasteur Institute was founded in 1901. That was the first institution of this kind in the settlements of South Slavs.

In a period of quick development of the city many sports associations were established, and the most important ones being: Knights' Shooting Club (1881), Moravian circuit of riders "Knjaz Mihajlo" (1890), Knights' Club "Dušan Silni" (1896), Gymnastic society "Soko" (1907).

Before the beginning of World war I the Government and the National Assembly were moved to Niš, which becomes the war capital of Serbia. The National Assembly made the Declaration in which the war goals were presented and the union of South Slavs and creating of their state was announced. (Declaration of Niš).

In October 1915 Niš is taken over by Bulgarian troops. By breakthrough of Macedonian Front by the First Serbian Army, led by Duke Petar Bojović, Niš gains its freedom on October 12, 1918. Since 1921 Niš becomes the center of Niš's district, which was comprised of 11 counties and 2 districts. During that time the city had around 25000 citizens. After the liberation, in a new country – Kingdom of Serbs, Croats and Slovans – Niš is, once again, built out of the ruins, old factories and workshops are reestablished and the new ones are built, some of them being: Shoe and Leather factory (1922), Chemical factory (1925), Printing "Sveti car Konstantin" (1927). Tramway on the route Niš-Niška Banja operates since 1930. Educational, cultural and other institutions are being reestablished. The development of Niš in that period is really limited by the World economic crisis (1929/33).

During World War II (1941-1945) Niš was under the German occupation. Niš was an important strategic point for the German army on their way to Thessaloniki and the Black sea. Arrests, torturing, murders and retaliation were common things in Niš during that time. Near the railroad station "Crveni krst" in Niš German army has build Concentrational camp through which more than 15000 patriots, members and supporters of People's Liberation Movement, Roma people and Jews has passed during the war. Thousands of people from the cam were shot at the Hill of Bubanj. A monument has been built on that place after war. Autenthical look of the Concentrational camp was preserved and in 1969 it was turned into the memorial museum "12. februar".

After the liberation, Niš is being rapidly renewed and developing. Many companies that have been destroyed or heavily damaged during the war were rebuilt and started operating again. In May 1948, „Zavodi RR“ was opened (later, Electronic industry of Niš), where the first radio produced in Serbia was made, 4 years after the company was founded, and in 1959 the first TV was made. Ferrous metal plant "Moravka" (nowadays, NISSAL) was put into operation in 1955. Mechanical Industry of Niš was created by the integration of railroad and mechanical workshop. Textile industry "Ratko Pavlović" (later on, "Nitex") started working in 1971. The first department store in Niš was opened in 1956. Alongside with that, many schools and cultural institutions were renewed, and many of them were founded after the liberation, for example: Radio station (1945) – later on Radio station Niš; City Orchestra (1946) – later on, Symphony Orchestra of Niš, the only one in the country outside of Belgrade; Archive center of Niš (1948), the National museum, Theatre of Marionette (1951) – later on the Puppet Theatre etc. In 1954 the Company for film production and broadcasting "Slavica" was founded, and, for a long period of time, on its disposal it had five movie halls.

Nowadays, Niš is a social, economical, educational, health, cultural and sport center of southeast part of Serbia, with population of over 250000 citizens. Niš is an important traffic node of European roads, railroads and plane routes. The city of Niš in 1992 becomes the center of the district of Niš. Consulate of the Republic of Greece was the first diplomatic representation in Serbia outside of Belgrade and it was opened on September 4, 1998.

Niš is an academic centre, with 13 faculties comprising the University and more than 15000 students. Around 40000 pupils are attending some kind of elementary and secondary education. A great potential of health facilities of Niš can be seen in thirty clinics and institutions (which are, in the same time, used by the students of Medical school) and a great number of other medical institutions.

The city of Niš has already celebrated hundred years since the first high school was built and the National theatre, the National library and literary magazine were founded. The institutions that dictate the tempo of region's cultural life are: the National theatre, the National library, the National museum, Symphony Orchestra, the Puppet Theatre, the Institute for National Heritage Preservation, University library, Historical archive, Gallery of Contemporary Art, „Dom kulture“, Cultural and Educational Community and a great number of organizations of Cultural-artistic amateurism.

In a series of cultural manifestations that take place in Niš and have national and international character some of the most important are: Festival of Actor's Achievements in Film, „Filmski susreti“, International Choir Festival „Horske svečanosti“, art colony “Sićevo” (the oldest one in the country), Music Festival of Niš (NIMUS) and Nišville Jazz Festival. The city of Niš also gives very prestigious award for poets - „Branko Miljković”.

The most important factors for development of sport in Niš are still clubs: Handball club “Železničar”, Female handball club “DIN”, Shooting club “Niš 1881”, Female football club “Mašinac”, Chess club “Železničar”, Football club “Radnički” etc.

UNIVERSITY OF NIŠ



Establishing Faculties in Niš was preceded by the establishment of higher educational institutions (Higher Educational Institution for Teacher Training, Higher Educational Institution for Economics, Administrative Higher Educational Institution and Technical Higher Educational Institution).

The first faculties in Niš started enrolling students in 1960/1961 under the auspices of University of Belgrade. There were three of them: Faculty of law and economics, Faculty of Medicine and Technical faculty. In the year when these faculties were established teaching was performed by the total of 20 professors and 19 assistants in full employment. 2317 students enrolled in these four faculties.

University of Niš was founded on June 15, 1965, which has rounded out an important, pioneering period in the recent history of the city. When the University was established, it had 234 teachers and associates and around 6000 students.

Development of new scientific disciplines, the increased economic and social need for professionals with high education and a steady increase in student numbers caused the reorganization of existing and establishing of new faculties. Hence, from the Technical Faculty three new faculties were established: Faculty of Electronical Engineering (1968), Faculty of Mechanical Engineering (1971) and Faculty of Civil Engineering (1971), and some time later Faculty of Occupational Safety (1972). In 1970, Faculty of Law and Economics becomes Faculty of Law and Faculty of Economics.

The first new Faculty at the University of Niš was established in 1972. It was the Faculty of Philosophy with 7 departments (Mathematics, Physics, Chemistry, Sociology, Psychology, English department and Physical education). Later on, two new faculties emerged: Faculty of Technology in Leskovac (1979) and Teacher-training Faculty in Vranje (1993).

By establishing the Department for architecture in 1995, Faculty of Civil Engineering changes its name into the Faculty of Civil Engineering and Architecture.

The biggest number of changes in organizations and teaching activities has had Faculty of Philosophy. Over time, from the Faculty of Philosophy, three new faculties „emerged“: Faculty of Science and Mathematics (1999); Faculty of Sports and Physical Education (1999); Faculty of Fine Arts (2002). University of Niš has launched an initiative with the Government of Serbia to establish two new faculties – Agriculture and Orthodox-Theological Faculty.

At the beginning of the new millennium, the University of Niš is comprised of 13 faculties with a number of departments, groups and profiles which offer diverse educational opportunities for bachelor, master and doctoral studies.

According to data from 2007/2008, University of Niš has a total of 1515 professors and associates, of which 133 are engaged on contract. From the total number of 25844 students, 433 were foreign citizens. Since its founding, over 41000 student from different profiles have graduated from the University of Niš. Academic title of Master of Science was given to 1869 postgraduates, and 1085 doctoral thesis were defended.

In the light of higher education system reforms and the implementation of Bologna declaration, the University of Niš was accredited on February 15, 2009, in accordance with the Law on Higher Education and by the decision of Commission for Accreditation and Quality Assessment of the Republic of Serbia.



Some very significant activities of the University are carried out through separate organizational units, which are called centres (Centre for Quality Improvement, Centre for International Cooperation, Centre for Multidisciplinary Studies, Research centre of SASA and University, Centre for Applied Physics etc.), the University Library "Nikola Tesla", the Unique University Informational system (JUNIS), Foundation for Resolving Residential Necessities, Board for ethical issues. Student's Parliament is an important body of the University, as well as a number of students' organizations (general or

vocational type) and the Students' Cultural Centre.

University of Niš has a developed publishing activity, which is reflected in the printing of scientific monographs, textbooks and other publications. The University is publishing a magazine dealing with social topics „TEME“ and scientific magazine in english „FACTA UNIVESITATIS“ (Architecture and Civil Engineering; Automatic Control and Robotics; Economics and Organization; Electronics and Energetics; Law and Politics; Linguistics and Literature; Mathematics and Informatics; Mechanical Engineering; Mechanics, Automatic Control and Robotics; Medicine and Biology; Philosophy, Sociology, Psychology and History; Physical Education and Sport; Physics, Chemistry and Technology; Working and Living Environmental Protection). The first editor in chief of the magazine was prof. Katica Hedrih, full professor at the Faculty of Mechanical Engineering in Niš.

At the University of Niš a great number of national and international projects are being implemented (TEMPUS, WUS).

University of Niš has a good cooperation with other Universities in Serbia and also with a number of foreign higher education institutions (Italy, Greece, United Kingdom, Russia, Germany, Norway, France, Republika Srpska). A number of prominent scientists from abroad were awarded the title of Honorary Doctor of Science of University of Niš.

University Building is located at the bank of the river Nišava, in the centre of the city. It was built in 1887 as the County Administration building. It was considered monumental and modern building in neorenaissance style with two floors and the main entrance from the quay. Current appearance of the building is from 1930, when Niš became administrative centre of Banovina of Morava.

FACULTY OF MECHANICAL ENGINEERING



The General Assembly of Socialist Republic of Serbia introduced the decision on May 18th 1960 by which Technical Faculty with the Departments for Mechanical Engineering, Electronical Engineering, Civil Engineering and Architecture was founded, thereby creating conditions for beginning the higher education in mechanical engineering. Registrar's Commission, established by the Council of the University of Belgrade, fulfilled all the necessary preparations so that the Technical Faculty in Nis started to work on 1st of October in 1960. In the first school year 1960/61, 145 full-time and 332 part-time students enrolled, and the classes were held in the building of Technical School. Since the 1964/65 the classes are held in the new building of Technological Faculty. During the first school year the Department for Mechanical Engineering had only two teachers and three associates permanently employed. In the early years of the Technical University of Nis classes at the Mechanical Engineering Department were largely held by professors from Faculty of Mechanical Engineering of Belgrade. Then curriculum envisaged a graded training (First level of studies - the first and second year, Second level - the third and fourth years).

In the following year, graded education was abandoned and the first generation of students whose education was based on the new curriculum which lasts for five years was enrolled. The new curriculum introduced orientation, with three new subjects on three profiles (railway, manufacture, construction). Apart from Chairs for Mathematics and Physics, which were common for all three profiles, the Department for Mechanical Engineering also included Chair for development of Machine Parts and Machines and Chair for Processing of Materials and Machine tools.

By the resolution of Council of technical Faculty from February 2nd 1971, approved by Parliament of Serbia on June 16th 1971, Department for Mechanical Engineering becomes Faculty of Mechanical Engineering of University of Niš. The Faculty now had a more clearly defined structure. At the moment of founding the Faculty had 19 lecturers and 16 associates, including 3 Ph.D.'s and 4 M.SC.'s. 11 Chairs were formed: Chair for Physics, Chair for Mathematics, Chair for Mechanics, Chair for Machine Structures, Chair for Hydraulics, Chair for Thermal Technology, Chair for Production Engineering, Chair for Automatics, Chair for Materials, Chair for Transport Engineering, Chair for Mechanics of Machines.

For the first dean of Faculty of Mechanical Engineering of Niš prof. Predrag Popović was elected.

The new Statute of Faculty of Mechanical Engineering from 1974 also included a new curriculum. It introduced education for qualifying as a mechanical engineer. Chairs were organized in a new way (a smaller number of chairs with a larger number of personnel) and the Institute for Mechanical Engineering was formed. The curriculum included six profiles at five-years studies (each containing 6 or 7 directing courses) and five profiles at two-year studies (each containing 5 directing courses). Statute from year 1987 adopted curriculum with nine profiles (manufacturing engineering profile, hydroenergetics profile, thermoenergetics and thermodynamics profile, mechanical constructions and mechanization profile, railway profile, engine and vehicle profile, precise mechanical engineering, process mechanical engineering profile).

By the end of the last century curricula has been changed several times, according to the increasing needs of the economy in our country and the rapid development of science and technology, particularly information technology. During that period names of some Chairs of the Faculty have been changed and some new Chairs were formed. However, some more radical changes in terms of reforms of higher education in Serbia took place at the beginning of the new millennium, which affected Faculty of Mechanical Engineering in Niš as well. So curriculum from year 2004, beside compulsory for the first time had optional courses on the final years of the studies.

Faculty of Mechanical Engineering in Niš has been permanently and intensively developing, so it is now one of the most prominent scientific and educational institutions in the country. The mission of the Faculty is the organization and implementation of academic and vocational studies and the development and implementation of scientific and technical research in the field of technical and



technological sciences. The vision of the Faculty is to become a respected and recognized institution in the field of higher education and scientific research in Serbia and to be recognized in the global academic environment. 95 professors and associates (some of them from other faculties) work at the Faculty today so that this goal could be achieved.

Including the data from the academic year 2009/2010, more than 3800 students have acquired a title of graduate mechanical engineer, 1220 students became mechanical engineers, 178 have become M.SC.'s and 100 have become Ph.D.'s.

In the academic year 2009/2010, 615 students were enrolled as undergraduates and 77 students were at their doctoral studies. From 1972 until 2005 Faculty of Mechanical Engineering has been organizing classes for postgraduate studies with different profiles.

Faculty of Mechanical Engineering of University of Nis, is now an independent educational and scientific institution, owned by the state, which in accordance with the Law on Higher Education in the educational and scientific fields of engineering and chemical engineering and the scientific field of Mechanical Engineering, from the academic year 2007/08. god., organize and implement three-level system of study:

- First degree studies (bachelor studies which last for 3 years in the field of Mechanical Engineering);
- Second degree studies (master studies which last for two years with more different profiles in the field of Mechanical engineering);
- Third degree studies (doctoral studies which last for 3 years, for different profiles, title – Ph.D. for Mechanical Engineering).

In master studies there are five modules (M1-M5), and PhD study program consists of six narrow scientific fields.

Faculty of Mechanical Engineering was accredited on April 11th 2009, in accordance with the Law on Higher Education and by the decision of Commission for Accreditation and Quality Assessment of the Republic of Serbia. The new curriculum is in accordance with the principles of the Bologna Declaration. Scientific research and cooperation with industry are organized by the Departments of the Faculty and the Institute of Mechanical Engineering, independently or in cooperation with other faculties or scientific research organizations from Serbia or abroad. With a large number of faculties, institutes and other organizations, local or international, the Faculty has signed contracts of cooperation.

Faculty of Mechanical Engineering currently has the following departments: Department for Production, IT and Management, Department for Thermal Energetics, Department for Construction, Development and Engineering, Department for Transportation Technology and Logistics, Department for Mechatronics and Management, Department for Hydroenergetics, Department for Natural and Mathematical Sciences, Department for Mechanics, Department for Social Sciences.

The following centres operate inside the Institute for Mechanical Engineering: Centre for Development and Design of Machines, Centre for Welding and Welded Structures, Centre for Transport and Logistics, Centre for Applied Mathematics, Centre for Nonlinear Dynamics and Active Structures. Alongside with these centres, there are few of them that operate as special organizational units: Regional Centre for Energy Efficiency Nis, Innovation Centre for development and application of Information Technologies, Centre for Engines and Vehicles.

The significant activities of the Institute for Mechanical Engineering are implemented through 19 laboratories: Laboratory for Machine tools and Processing, Laboratory for Mechanical Materials, Laboratory for Thermal Technology and Energetics, Laboratory for Operating Materials, Laboratory for Hydraulic Machines, Laboratory for Motors and Motor vehicles, Laboratory for Intelligent Manufacturing Systems (LIPS), Laboratory for transfer of new technologies CIM – TTC, Laboratory for Automatization, Laboratory for Metrology, Laboratory for Mechanical Constructions, Laboratory for Mechatronics, Laboratory for System Management, Laboratory for Transporting Techniques, Laboratory for Physics, Laboratory for Electrical Engineering, Laboratory for Welding, Laboratory for Experimental Mechanics.

Institute of Mechanical Engineering was awarded ATC accreditation for five laboratories (Laboratory for testing of materials and machines, Laboratory for Thermotechnics, thermoenergetics and process engineering; Laboratory for hydraulic and pneumatic testing; Laboratory for mechanisms and machinery, Transport technics Laboratory), making the Faculty of Mechanical Engineering in Nis an institution with the largest number of accredited laboratories in the country.

In the organizational structure of the faculty an important place occupies Information System (formerly-The computer center). The computer system has a large number of application software and licensed

software for CAD / CAM. Nine computer labs has 120 modern computers, and on the faculty there are installed over 450 computers. Today, all computers at the faculty are connected by optical cable to the Computer Centre of University of Nis (JUNIS), and further with the Serbian academic network and the Internet. All computers in computer classrooms are available to students.

Among the many contracts and agreements on cooperation with ICT companies, membership of Mechanical Engineering in Nis in the Microsoft MSDN Academic Alliance program should be mentioned, which provides teachers and students with many benefits in terms of access to the latest software products from Microsoft.

Library of the Faculty of Mechanical Engineering began working from the founding of the Technical University of Nis, modestly, with a few thousand books and dozens of magazines. Library now has over 16,000 books, gifts and legacies, and hundreds of domestic and foreign magazines. The library has a rich database that can be accessed via the Internet. Also, there is the ability to search other libraries through COBSON network.

Students of Mechanical Engineering in Nis, act through the Association of Students of Mechanical Engineering, Sports Association of Faculty of Mechanical Engineering and the Student Parliament. Diverse cultural activities, achievements in knowledge and various sports on "Mašinijada" and other competitions, they gave a significant contribution to the promotion and reputation of the Faculty of Mechanical Engineering.

Department for Human and Material Resources is an organizational unit of Faculty of Mechanical Engineering in charge of normative-legal, material, financial, administrative and other affairs. Tasks of this sector are divided into three organizational units: Department for Human Resources, Department for Material Resources and the Department for Educational and Student Affairs.

In recent years professors and associates from Faculty of Mechanical Engineering have worked on implementation of several international projects and over 30 national projects in the fields of Basic Research, Technological Development and Energy Efficiency financed by the Ministry of Science of the republic in Serbia. At the Faculty testing of vehicles can be done, testing and calibration of manometers, as well as realization of different kind of studies, revisions, supervising, expertising, measuring, designing of the equipment and tools for the industry.

The participation of professors and associates in scientific and expert seminars and conferences, domestic and international, is notable. Faculty of Mechanical Engineering traditionally organizes conferences and seminars of national and international importance: (International Symposium of Nonlinear Mechanics (ISNM), Scientific-expert conference on railways (ŽELKON), Symposium of Transport and Logistics (TIL), Conference on Sustainable Development and Climate Changing (SUSTAIN)), as well as other scientific and professional congresses that are periodically held at Faculty of Mechanical Engineering (Conference on Production Engineering, IFToMM, HIPNEF, SIMTERM etc.).

DEPARTMENT FOR PRODUCTION, IT AND MANAGEMENT

Department for Production, IT and Management was founded in 1966 as Department for Processing and Machine tools, with several permanently employed lecturers and assistants covering only a few subjects. On the beginning, it was acknowledged at all the mechanical engineering faculties in Yugoslavia as scientific research unit that primarily deals with the theoretical and practical issues in processing by forming. Since then, the Department has greatly extended its scientific and research activities, so nowadays it deals with almost entire field of manufacturing mechanical engineering.

With the development of the faculty, the department developed and continuously expanded its educational, scientific and research activity, which lead to change of its name into Department for Production Engineering in 1972.



In the first few decades of Faculty of Mechanical

Engineering in Niš, then Department for Production Engineering possessed the largest scientific and educational potential and it presented the basis for the development of the entire Faculty. The largest number of students at the Faculty was enrolling at the profile of Production Engineering.

From the beginning of the Department for Production Engineering, organized classes in study profile "Production engineering", in the period from 1972. to 2005. also post-graduate studies at the profile under the same name. Studies on this specified profile included joint teaching courses, courses on several profiles (Machining technologies, Forming and shaping technologies, Computer aided manufacturing technologies) and optional courses. In recent years, this studies are organized with four semesters, with a total of six elective courses following the scheme: A11 (Theoretical examination), A12 (General professional subjects), 2B1 (Professional subjects) and B2 (Immediate professional subjects). In addition, members of the Department are held lectures on several general courses for all students of Mechanical Engineering (Mechanical Materials, Manufacturing technologies, Production organization). During this period, lecturers also held courses at Faculty of Mechanical Engineering in Pristina, Technical Faculty in Bor and centers of our faculty in Smederevo and Paracin.

During that period, the Department for Production Engineering was the pioneer in many activities at the Faculty. This Department started the first postgraduate studies (1972/1973), published the first magazine, implemented the first scientific research project (financed by the state i.e. by the Ministry of Science), organized the first scientific-expert congress etc.

In 1975 the Department began to organize scientific and professional conferences; it also started to publish the publication "Means and Methods of Metal Forming"). Nine scientific and professional conferences were held entitled: "Oscillations of Forming Systems in Metal Forming and Identification of Phenomena Affecting Its Structural and Technological Properties", "Manufacture of Elements by Deep Drawing Method", "Steel Sheet Processing by Drawing and Assessment of Steel Sheet Workability", "Automatization of Technological Procedures", "Bulk Metal Forming", "Carrying Structures of Presses" and "Metal Forming by Explosion". Faculty of Mechanical Engineering in Niš, that is the Department for Production Engineering has issued the three issues (3., 4. And 5.) of the Yugoslav journal „Metal Forming in Mechanical Engineering“, which is issued in English for the past twenty years in Novi Sad with the title: „Journal for Technology of Plasticity“. Longtime editors of the scientific magazine Facta



Universitatis – Series: Mechanical Engineering were the members of this Department (Prof. Predrag Popović, Prof. Miodrag Stojković). There are permanent members from this Department in editorial boards of "Journal for Technology of Plasticity" and "IMK14-Research and Development". Together with the associations of tool workers of Belgrade and Nis, the Department organized professional seminar entitled "Methods and Tools for Bulk Forming and Forging" in 1980; the manual with the same title, edited by Professor Predrag Popovic, was also published. Due to its importance and scale it is worth mentioning four cycles of PRISMA as retraining programme for the former members of the Army. Programme lasted from 2005. to 2008., and the most important participants were the members

of the Department for Production, IT and Management.

Until now, the department had a privilege to organize three times (1974, 1984 and 1998) the biggest national conference in mechanical engineering under the title "Conference on Production Engineering of Yugoslavia". The next conference is held in Nis under the name of "International Conference on Production Engineering", also organized by Department for Production, IT and Management.

In cooperation with the Association of Mechanical and Electrical Engineers and Technicians of Serbia three scientific conferences were held - "HIPNEF" (2002., 2004. and 2008.). Members of the department participated in organizing two international CIM seminars, and many other seminars and courses within the regular activities, firstly of the Computer Center of Faculty of Mechanical Engineering in Nis, and latter of Innovation Centre for Information Technology (ICIT).

In 1980s the Department was engaged in the organization of Municipal Competition of Metal Workers of Niš. Its members constantly participated in in the work of the Jury for the Republican contest of the Metal Workers of Serbia (Lj. Janković, V. Marinković, B. Rančić). The department is constantly has its representative in the Executive Committee of the Community of Scientific Research Institutions for Manufacturing engineering of Yugoslavia, and latter Serbia, since it was established in year 1994.

Members of the Department for Production, IT and Management were members of the organization and / or scientific committees of numerous scientific conferences and symposia. In many of these conferences in the country and abroad they participated with their papers.

For outstanding contribution to the development of the production engineering in the former Yugoslavia and Serbia several professors of the Department have received the highest recognition in our profession – Charter and Plaques "Prof. dr Pavle Stanković" (Prof. Predrag Popović, Prof. Vojislav Stoiljković, Prof. Dragan Domazet, Prof. Velibor Marinković).

The impressive development of science and technology in recent decades included the development and winning new propulsion systems, flexible systems, computer-controlled machines, machining centers and robots, automated lines, then, the development of productive and non-conventional technologies, new tools, instruments and measuring machines and units, sensors and other components for regulation and control etc.. In such circumstances the need for mechanical engineers to poses expanded to integrate knowledge from many fields appeared, and department introduced a number of new courses in the field of information technology and management. In the year of 2004. it got its current name: Department for Production, IT and Management.

According to a newest curriculum, according to the principles of the Bologna Declaration and the High Education Act from year 2006., there is a new system of studying with three accredited study programs and a number of modules. Module for Production, IT and Industrial Management the lectures are held during master studies and PhD studies. In the program in addition to compulsory subjects, a large number of elective courses have been introduced. In this way, students are allowed to, according to their own preferences and interests, create a unique system of education in the selected module, in order to acquire those theoretical and practical knowledge and skills that are necessary for their future professional work. In pursuance of the name the module, students are offered a balance between courses in the fields of production engineering, information technologies and management.

Teaching staff of the department have printed over 30 monographs, textbooks, manuals and books of problems.

Until today 1494 students graduated at the department since its establishment. Under the direction of the professors of the department 32 doctoral thesis and 42 master thesis were defended. Professors from the Department were members of many committees for assessment of doctoral dissertations and master thesis at other faculties and universities in the country and in the former Yugoslav republics (Faculty of Mechanical Engineering of Belgrade, Kragujevac, Banja Luka, Mostar and Podgorica, Faculty of Technical Sciences-Novi Sad, Faculty of occupational safety of Nis).

Scientific research of the department includes the following fields:

- Design and testing of machines and tools
 - Diagnostics and maintenance of mechanical systems
 - CNC machines programming
 - Integration of CAD/CAPP/CAM systems
 - Development and application of IT technologies for design and simulation of products and technological processes
 - Design and optimization of (non)conventional technological processes
 - Application of artificial intelligence for the modeling of technological processes
-

- Automatization of manufacturing processes
- Rapid product development
- Digital control systems
- Engineering metrology
- Development of systems for assembling and packaging
- Processes management and quality tools
- Business processes management
- E-business
- Recycling technologies
- Heat treatment of metals

Under the jurisdiction of the Department for Production, IT and Management are the following laboratories:

- Laboratory for machine tools and processing;
- Laboratory for mechanical materials;
- Laboratory for automatization;
- Laboratory for intelligent manufacturing systems (LIPS);
- Laboratory or transfer of new technologies (CIM-TTC);
- Laboratory for metrology.

Accredited Laboratory for testing materials and machines also belongs to the Department.

The first manager of the Computer Center of the Faculty of Mechanical Engineering was professor Dragan Domazet from the Department of Manufacturing Engineering as it was named then. The manager and the main collaborators of Innovation Centre for Information Technology are from the Department of Manufacturing, IT and Management.

Members of the department successfully implemented a number of scientific research and innovation projects, financed by the Ministry of Science and Technology of the Republic of Serbia, as well as dozens of projects for the industry. In this regard the department has made very good cooperation with many companies (Mechanical industry-Nis, Electronic industry-Nis, Nissal-Nis, Tigar-Pirot, Lemind-Leskovac, RTB-Bor, Trayal-Krusevac, Nicrooprema-Paraćin, Vunizol-Surdulica, Copper pipes factory-Majdanpek etc.). In recent years, participation of lecturers and staff of the Department for Production, IT and Management in the development of number of international projects has been noted.

Department today form eight professors, two associate professors, three assistant professors and eight assistants in full-time employee. Department is now able to maintain a complete education of accredited study program. The full-time employed lecturers and associates of the Department of Production, IT and Management are: Prof. Miroslav Trajanović (the Chairman of the Department), Prof. Dragoljub Lazarević, Prof. Dragan Temeljovski, Prof. Miodrag Manić, Prof. Bojan Rančić, Prof. Miroslav Radovanović, Ass. Prof. Goran Radenković, Ass. Prof. Peđa Milosavljević, Asst. Prof. Saša Ranđelović, Asst. Prof. Predrag Janković, Asst. Prof. Dragan Mišić, Asst. Prof. Vladislav Blagojević, assistant Miloš Stojković, assistant Nikola Korunović, assistant Jelena Milovanović, assistant Milan Zdravković, assistant Dušan Petković, assistant Nikola Vitković, assistant Milan Trifunović and laboratory technician Novica Jovanović.

Founder and Chairman of the department for many years was Prof. Predrag Popović, and afterwards for this function Prof. Aleksandar Pavlović, Prof. Vojislav Stoiljković, Prof. Velibor Marinković and Prof. Dragan Domazet were elected.

In the meantime, some members of the Department responsible for its development and affirmation have retired: Prof. Milivoj Božin, Prof. Časlav Vučković, Prof. Aleksandar Pavlović, Prof. Svetislav Zarić, Prof. Miroslav Drezgić, Prof. Ljubomir Janković, Prof. Dušanka Vukićević, Prof. Vojislav Stoiljković, Prof. Velibor Marinković and Prof. Miodrag Stojiljković. Unfortunately, some of the first members of the Department have passed away: dipl.ing. Ljubomir Pejović, dipl.ing. Pavle Dražić, Asst. Prof. Božidar Mitić, Prof. Miroslav Pavlović, Prof. Nenad Mileusnić, Prof. Vladimir Ognjanović, Prof. Vuksan Bulat, Prof. Predrag Popović, assistant Ljubomir Bogdanov and laboratory technician Gorjan Đurđanović.

Miroslav D. Trajanović, Ph.D., full professor

The chairman of the Department

E-mail: traja@masfak.ni.ac.rs

Tel.: +381 (18) 500 662



Personal data

- Prof. Miroslav D. Trajanović was born in Niš, Serbia
- Graduated at the Faculty of Mechanical Engineering in Niš in 1978
- Finished his postgraduate studies at the Faculty of Mechanical Engineering in Niš in 1986
- Got his Ph.D. at the Faculty of Mechanical Engineering in Niš in 1995

Courses

Bachelor/master studies

- Fundamentals of information and communications technology
- Information systems
- Computer aided products design
- Application of FEM
- Systems for rapid product development

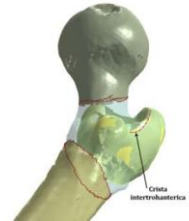
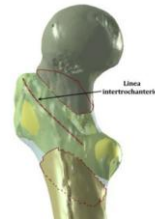

Doctoral studies

- Selected chapters from production-information systems
- Production information systems
- Interoperability and integration of systems



Field of scientific work

- Application of information technologies in manufacturing
- Rapid prototyping technologies and reverse engineering
- Simulation of product's behavior in the conditions of exploitation

Selected published scientific papers

- J. Milovanovic, M. Stojkovic, M. Trajanovic, Rapid Tooling of Tyre Tread Ring Mould Using Direct Metal Laser Sintering, **JSIR**, Vol.68(12), December 2009, pp 1038-1042.
- Mišić D., Domazet D., Trajanović M, Manić M., Zdravković M., Concept of the exception handling system for manufacturing business processes, **Computer Science and Information Systems** (ComSIS), 2010, 7(3):489-509, DOI:10.2298/CSIS090608006M, ISSN: 1820-0214
- Mišić D., Stojkovic M., Domazet D., Trajanović M, Manić M., Trifunovic M., Exception detection in business process management systems, **JSIR-Journal of Scientific Industrial Research**, Vol.69(03), March 2010, pp 1038-1042, <http://nopr.niscair.res.in/handle/123456789/7377>, ISSN: 0975-1084 (Online); ISSN: 0022-4456 (Print)
- Milos Stojkovic, Jelena Milovanovic, Nikola Vitkovic, Miroslav Trajanovic, Nenad Grujovic, Vladimir Milivojevic, Slobodan Milisavljevic, Stanko Mrvic, Reverse modeling and solid free-form fabrication of sternum implant, **Australasian Physical & Engineering Sciences in Medicine**: Volume 33, Issue 3 (2010), Page 243-250, DOI: 10.1007/s13246-010-0029-1
- Milan Zdravković, Hervé Panetto, Miroslav Trajanović, Alexis Aubry, An Approach for Formalizing the Supply Chain Operations, **Enterprise Information System**, Volume 5, Issue 4, Taylor & Francis Group, 2011, Page 401-421, DOI:10.1080/17517575.2011.593104
- Nikola Korunović, Miroslav Trajanović, Miloš Stojković, Dragan Mišić, Jelena Milovanović, Finite Element Analysis of a Tire Steady Rolling on the Drum and Comparison with Experiment, **Strojniški vestnik - Journal of Mechanical Engineering**, 57(2011)12, 888-897, DOI: 10.5545/sv-jme.2011.124
- Milos Stojkovic, Jelena Milovanovic, Nikola Vitkovic, Miroslav Trajanovic, Stojanka Arsic, Milorad Mitkovic, Analysis of femoral trochanters morphology based on geometrical model, **JSIR-Journal of Scientific Industrial Research**, Vol.71(03), March 2012, pp 210-216

Dragoljub B. Lazarević, Ph.D., full professor

E-mail: dlazarevic@masfak.ni.ac.rs

Tel.: +381 (18) 500 625



Personal data

- Prof. Dragoljub B. Lazarević was born in Valjevo, Serbia
- Graduated at the Faculty of Mechanical Engineering in Niš in 1974
- Finished his postgraduate studies at the Faculty of Mechanical Engineering in Niš in 1983
- Got his Ph.D. at the Faculty of Mechanical Engineering in Niš in 1988

Courses

Bachelor/master studies

- Production resources
- Tools and devices
- Non-conventional machining
- Machine and tools for polymer productions
- Forming tools

Doctoral studies

- Contemporary methods of machining
- Advanced non-conventional manufacturing technologies
- Processing of polymer materials

Field of scientific work

- Forming tools
- Tools for processing of polymer materials
- Non-conventional manufacturing technologies

Selected published scientific papers

- Lazarević D., Lazarević A., Mathematical Modelling of Cutting Processing by Plasma, **IV International Conferenss**, Varna, Bulgaria, 2004.
- Lazarević D., Manić M., Lazarević A., Prototype expert system for performing the plasma cutting process, **18th Inter. Conference on Production Research**, Salerno, Italy, 2005.
- Manić M., Lazarević D., Radovanović M., Application of Expert Systems and Artificial Neural Networks in Manufacturing, **International Conference on Manufacturing Science and Education-MSE 2009**, Sibiu, Romania, 2009.
- Lazarević D., Analysis of Pressures, Forces and Torsion Moments on the Rollers while Profiling Steel Sheet into the Trough Shapes, **MTM'97-International Conference on Mechanical Transmissions and Mechanisms**, Tianjin, China, 1997.
- Lazarević D., Hydraulic shaping thorn for rotary narrowing, **ASME Internacional GREEK Section**, Patras, Greece, 2001.
- Lazarević D., Naprjaženo-deformirvano sastajanje pri kombinovanomu metodi rotacionova vitjažanjija cilindričnih detalje, **International Symposium of Ukrainin Mechanical Engineers in Lviv**, Lviv, 1993.
- Lazarević D., Dimensions of the Mould Hollow for Manufacturing Thermoplastic Gear by injection, **The third International conference on motion and vibration control**, Chiba, Japan, 1996.
- Lazarević D., Effect of the Point of Transition from the Injection Pressure to the Subsequent Pressure and of the Subsequent Pressure Duration upon the Pressure curve in the Mould Hollow, **3rd Internatinal Conference, Research and Development in Mechanical Industry**, Herceg Novi, Serbia and Montenegro, 2003.
- Radovanovic M., Lazarevic D., Technological Aspects of Laser Cutting of Sheet Metals, **4th International Conference on Advanced Manufacturing Systems and Technology - AMST'96**, Udine, Italy, 1996.

Dragan I. Temeljovski, Ph.D., full professor

E-mail: temelj@masfak.ni.ac.rs

Tel.: +381 (18) 500 630



Personal data

- Prof. Dragan I. Temeljovski was born in Brežice, Slovenia
- Graduated at the Faculty of Mechanical Engineering in Niš in 1978
- Finished his postgraduate studies at the Faculty of Mechanical Engineering in Niš in 1987
- Got his Ph.D. at the Faculty of Mechanical Engineering in Niš in 1990

Courses

Bachelor/master studies

- Production resources
- Selected chapters from the section on informational production technologies and industrial management
- Machine tools
- Machine and tools for polymer productions
- Recycling technology Doctoral studies
- Selected chapters from polymer processing
- Modeling and simulation of machining resources

Field of scientific work

- Machine tools
- Machines for polymer processing
- Recycling technology



Selected published scientific papers

- Temeljovski D., Popović P., Ristić J., Screw Press Available Energy Programming by the Variable Flywheel Inertia Moment - Simulation and Experiment, **Journal of Automatic Control**, Vol. VII (1), 1996.
- Temeljovski D., Popović P., Ristić J., Screw Press Available Energy Programming by the Variable Flywheel Inertia Moment, **Journal of Automatic Control**, Vol. VI (1), 1996.
- Popović P., Temeljovski D., New Trends in Flexible Working Systems Realisation in Technology of Plasticity, **FACTA UNIVERSITATIS, Series: Mechanical Engineering**, Vol. 1, No 3, 1996.
- Temeljovski D., Mijailović V., Nusev S., Metal forming machines with the flywheel inertia variable moment., 7th International Conference on Technology of Plasticity, **Proceedings of a Advanced Technology of Plasticity 2002**, Vol. 2, Yokohama, Japan, 2002, pp. 961-966.
- Djekić P., Temeljovski D., Banić M., Nusev S., Razvoj sistema za recikliranje otpadnog ulja primenom TRIZ metode, **IMK-14 Istraživanje i razvoj**, Kruševac, Serbia, 2010, Godina XVI, Broj (34) 1, str. 57-64.
- Temeljovski D., Djekić P., Rančić B., Nusev S., Possibility of Application of rubber powder at NR/SBR Mixture, **International Conference Mechanical Engineering in XXI Century**, Niš, Serbia, 2010, pp. 213-216.
- Temeljovski D., Popović P., Rančić B., Djekić P., Evaluation of Product and Production Technologies Quality Method of Superiority and Inferiority, **34th International Conference on Production Engineering**, Niš, Serbia, 2011, pp. 267-270.
- Djekić P., Temeljovski D., Rančić B., Nusev S., Application of recycled rubber powder (RRP) in NR/SBR compounds, **Journal of Scientific & Industrial Research**, Vol. 71, April 2012, pp. 295-298.
- Djekić P., Temeljovski D., Rančić B., Nusev S., Modern Technologies of Recycling of Polymeric Materials and their Application in the Production of new materials, **7th International Symposium KOD 2012**, Balantofured, Hungary, 2012, pp. 485-488.

Miodrag T. Manić, Ph.D., full professor

E-mail: miodrag.manic@masfak.ni.ac.rs
 Tel.: +381 (18) 500 631



Personal data

- Prof. Miodrag T. Manić was born in Bela Palanka, Serbia
- Graduated at the Faculty of Mechanical Engineering in Niš in 1980
- Finished his postgraduate studies at the Faculty of Mechanical Engineering in Niš in 1989
- Got his Ph.D. at the Faculty of Mechanical Engineering in Niš in 1995

Courses

Bachelor/master studies

- Production systems
- Programming of CNC machine tools
- Technological processes planning
- E business
- Selected chapters from the section on informational production technologies and industrial management
- CNC systems
- Production systems
- CAPP/CAM systems

Doctoral studies

- Virtual product development
- Integral product development
- Simulation in product development
- Computer aided manufacturing

Field of scientific work

- Application of information technologies, including methods of artificial intelligence – CAPD
- Computer numerically controlled machine tools and their programming (CNC systems)
- Technology and manufacturing systems

Selected published scientific papers

- Manić M., Miltenović V., Stojković M., Feature Models in Virtual Product Development, **FACTA UNIVERSITATES, Series: Mechanical Engineering**, No 10, 2003, pp. 1327-1337.
 - Stojković M., Manić M., Trajanović M., Knowledge-Embedded Template Concept, **CIRP - Journal of Manufacturing Systems**, WISU-Vergal Aachen, Vol. 34, No 1, 2005.
 - Manić M., Stojković M., Mišić D., Đurišić Z., Manufacturability Analysis Using Feature Based Design, **International Conference on COMPUTER INTEGRATED MANUFACTURING, Advanced Design and Management**, Gliwice, Poland, 2003.
 - Manić M., Tanikić D., Nikolić V., Determination of the Cutting Forces in a Face Milling Operation Using the Artificial Neural Networks, **Machine Dynamics Problems**, Vol. 29, No 3, 2005.
 - Stojkovich M., Manich M., Trajanovich M., Korunovich N., Semantic Structures In The Product Data Model, **Proceedings: Product Lifecycle Management Accessing the industrial relevance – SP3**, Bergamo, Italy, 2007, pp. 227-234.
 - Lazarević A., Manić M., Lazarević D., Prototype expert system for performing the plasma cutting process, **18th Inter. Conference on Production Research**, Salerno, Italy, 2005.
 - Stojković M., Manić M., Trajanović M., On Semantics of Design and Manufacturing Feature in Digital Product Model, **2nd International Conference on Manufacturing Engineering ICMEN and EUREKA Brokerage Event**, Kallithea, Greece, 2005, pp. 731-740
 - Tanikić D., Manić M., Radenković G., Mančić D., Metal cutting process parameters modeling: an artificial intelligence approach, **JOURNAL OF SCIENTIFIC & INDUSTRIAL RESEARCH**, Vol. 68, No 6, 2009, pp. 530-539.
-

Bojan M. Rančić, Ph.D., full professor

E-mail: bojanr@masfak.ni.ac.rs
 Tel.: +381 (18) 500 627

Personal data

- Prof. Bojan M. Rančić was born in Pirot, Serbia
- Graduated at the Faculty of Mechanical Engineering in Niš in 1978
- Finished his postgraduate studies at the Faculty of Mechanical Engineering in Niš in 1987
- Got his Ph.D. at the Faculty of Mechanical Engineering in Niš in 1993

Courses

Bachelor/master studies

- Production resources
- Measurement and control
- Selected chapters from the section on informational production technologies and industrial management
- Engineering metrology
- Measurement and data acquisition systems

Doctoral studies

- Methods and organization of scientific research with metrology
- Modeling and analysis of measuring systems
- Advanced forming technologies

Field of scientific work

- Forming technologies
- Engineering metrology

Selected published scientific papers

- Marinković V., Nikolić J., Rančić B., Analysis of hole flanging process in stainless steel sheet, **Journal for Technology of Plasticity**, Vol. 26, No 2, 2001.
 - Rančić B., Janković P., Stoiljković V., An expression suggested to determine the blank holder pressure in the oil hydraulic process of square cups deep drawing, **Journal for Technology of Plasticity**, Vol. 31, No 1-2, 2006.
 - Rančić B., Janković P., Marinković V., Determining the transitional area of square cups in oil hydraulic forming process, **Journal for Technology of Plasticity**, Vol. 31, No 1-2, 2006.
 - Lazarević D., Rančić B., Lazarević A., Experimental research of the quality of processing by plasma cutting, **4th International Conference "Research and Development in Mechanical Industry"- RaDMI 2004**, Zlatibor, 2004.
 - Rančić B., Jovanović G., Eksperimentalna provera izraza za određivanje sile provlačenja, **IMK-14, Istraživanje i razvoj**, br. 10, 1998.
 - Rančić B., Janković P., Planić S., Vukadinović N., Konstruisanje i tenzometrijsko ispitivanje C-spojnice za željezničke šine, **Istraživanja i projektovanja za privredu (IIPP)**, godina IV, br. 14, 2006.
 - Rančić B., Stoiljković V., Janković P., Determination of the Bottom Cup Holder Force in the Oil Hydraulic Process of Square Cups Deep Drawing, **Journal of Mechanical Engineering**, (rad prihvaćen za štampu).
-

Miroslav R. Radovanović, Ph.D., full professor

E-mail: mirado@masfak.ni.ac.rs
Tel.: +381 (18) 500 626



Personal data

- Prof. Miroslav Radovanović was born in Čičevac, Serbia
- Graduated at the Faculty of Mechanical Engineering in Niš in 1977
- Finished his postgraduate studies at the Faculty of Mechanical Engineering in Belgrade in 1987
- Got his Ph.D. at the Faculty of Mechanical Engineering in Niš in 1996
- He was employed at the IMC „14. Oktobar“ in Kruševac, from 1977 till 1989

Courses

Bachelor/master studies

- Manufacturing technologies
- Production resources
- Tools and devices
- Cutting technologies
- Modeling and optimization of manufacturing processes

Doctoral studies

- Selected chapters from production-information systems
- Contemporary methods of machining
- Advanced non-conventional manufacturing technologies
- Modeling and optimization of processes

Field of scientific work

- Cutting technologies
- Non-conventional technologies
- Modeling and optimization of processes

Selected published scientific papers

- Radovanović M., Some Possibilities for Determining Cutting Data when Using Laser Cutting, **Journal of Mechanical Engineering**, Vol. 52, No 10, 2006, pp. 645-652.
- Radovanović M., Dasic P., Research on Surface Roughness by Laser Cut, **The Annals of University "Dunarea de Jos" of Galati**, Fascicle VIII, Tribology, 2006 (XII), pp. 84-88
- Radovanović M., Abrasive Waterjet Cutting Cost, **Nonconventional Technologies Review**, No 1, 2007, pp. 97-102.
- Radovanovic M., Characteristics of Material in Zone of Cut by Laser Cutting, **The Annals of University "Dunarea de Jos" of Galati**, Fascicle VIII, Tribology, 2010 (XVI), pp. 42-45
- Radovanovic M., Marinkovic V., Graphical-Analytical Method for Determining the Optimal Cutting Parameters, **The International Conference Mechanical Engineering in XXI Century**, University of Nis, Faculty of Mechanical Engineering, Nis, Serbia, 2010, pp. 171-174
- Radovanovic M., Madic M., Modeling of Surface Roughness Using MRA and ANN Method, **Annals of the Oradea University**, Fascicle of Management and Technological Engineering, Vol.X (XX), 2011, pp. 2.81-2.86
- Radovanovic M., Slatineanu L., Jankovic P., Analytical Modeling of Traverse Rate in Abrasive Water Jet Cutting of Aluminum 6061-T6, **International Scientific Conference UNITECH'11**, Vol. II, Technical University of Gabrovo, Gabrovo, Bulgaria, 2011, pp. II 409-II 414
- Madic M., Radovanovic M., Comparative Modeling of CO₂ Laser Cutting Using Multiple Regression Analysis and Artificial Neural Network, **International Journal of Physical Sciences**, Vol. 7(16), 2012, pp. 2422-2430
- Madić M., Radovanović M.: Investigation Into the Effect of the Cutting Parameters on the Burr Height in CO₂ Laser Nitrogen Cutting of AISI 304 Stainless Steel, **Metalurgia International**, Vol. XVII, No. 7, 2012, pp. 74-78

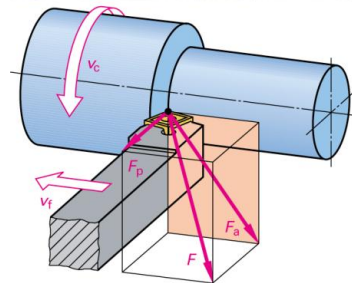

Goran M. Radenković, Ph.D., associate professor

E-mail: rgoran@masfak.ni.ac.rs

Tel.: +381 (18) 500 696

**Personal data**

- Ass. Prof. Goran M. Radenković was born in Leskovac, Serbia
- Graduated at the Faculty of Mechanical Engineering in Niš in 1979
- Finished his postgraduate studies at the Faculty of Mechanical Engineering in Niš in 1988
- Got his Ph.D. at the Faculty of Technology and Metallurgy in Belgrade in 2001

Courses

Bachelor/master studies

- Technical materials
- Selected chapters from the section on informational production technologies and industrial management
- Coating and surface hardening technology
- Welding technology 2
- Weldability of materials

Doctoral studies

- Exploitation behavior of materials
- Selected chapters of welding construction

Field of scientific work

- Heat treatment of metals
- The structure of metals
- Electrochemical Corrosion

Selected published scientific papers

- Radenković G., Uticaj termičke obrade na mikrostrukturu i svojstva livenog nerđajućeg čelika austenitno-feritnog tipa. **Tehnološko-metalurški fakultet Univerziteta u Beogradu**, Beograd, 2001.
 - Radenković G., Cvijović Z., Zečević S. K., Mihajlović D. V., The influence of microstructure modified by rapid solidification on corrosion behavior of cast duplex stainless steels. **Prakt. Met. Sonderband**, 26, (1995), pp. 295-307.
 - Cvijović Z. M., Knežević V. R., Mihajlović D. V., Radenković G., Elevated Temperature Effect on the Structural parameters Important in Corrosion of Duplex Stainless Steels. **Acta sterol**, 18 (1999), pp. 305-312.
 - Radenković G., Cvijović Z. M., Zečević S. K., Mihajlović D. V., Surface melting effect on the corrosion behaviour of austenitic-ferritic stainless steels solidified in various models,. **Materials Science Forum**, 352 (2000), pp. 213-218.
 - Cvijović Z., Radenković G., On the relation between microstructural state and stable pitting in duplex stainless steels. **Prakt. Met. Sonderband**, 34 (2003), pp. 83-90.
 - Cvijović Z., Radenković G., Microstructure and pitting corrosion resistance of annealed duplex stainless steel, **Corrosion Science**, 48 (12) (2006), 3887-3906.
 - Cvijović Z. Radenković G., Pitting Corrosion Damage of Cast Duplex Stainless Steels: Role of Microstructure. **5th chapter of book Corrosion Research Trends**, Editors: I. S. Wang, Nova Science Publishers.
-

Peđa M. Milosavljević, Ph.D., associate professor

E-mail: pedja@masfak.ni.ac.rs
Tel.: +381 (18) 500 714



Personal data

- Ass. Prof. Peđa M. Milosavljević was born in Niš, Serbia
- Graduated at the Faculty of Mechanical Engineering in Niš in 1992
- Finished his postgraduate studies at the Faculty of Mechanical Engineering in Niš in 1997
- Got his Ph.D. at the Faculty of Mechanical Engineering in Niš in 2005

Courses

Bachelor/master studies

- Introduction to management
- Industrial management
- Lean Six Sigma enterprise
- Maintenance of technical systems
- Supply chain management

Field of scientific work

- Industrial management
- Management of business processes
- Maintenance of technical systems

Selected published scientific papers

- V. Stoiljković, P. Milosavljević, S. Ranđelović, **Industrijski menadžment, praktikum**, Mašinski fakultet Univerziteta u Niš, Niš, 2010., 368 str.
- P. Milosavljević, **Održavanje alatnih mašina - tehnički vek i ciklusi**, monografija, Biblioteka Academia, Zadužbina Andrejević, Beograd, 1999.
- V. Stoiljković, P. Milosavljević, S. Ranđelović, **Six Sigma Concept within Banking System**, African Journal of Business Management, Vol. 4, Num. 8, July 2010., Nairobi, Victoria Island, Nigeria. Page 1480-1493.
- P. Milosavljević, S. Jovanović, D. Jovanović, G. Radoičić, V. Blagojević, **Simulation and experimental stress analysis of waste compression assembly in utility vehicles for the removal of communal waste "Norba" type with two actuators**, Facta Universitatis, Series: Mechanical Engineering, Vol. 8, No 1, 2010, Niš. Page 9-18.
- P. Milosavljević, M. Manojlović, A. Berket Bakota, M. Marković, **Improvement of patient admission process of in health institution „Health Care Center“ Niš**, International Journal Advanced Quality, Vol. 40, No.1, Page 17-22, 2012.
- P. Milosavljević, D. Živković, P. Janković, S. Mladenović, **The Possibilities for Improvement of the Maintenance Processes in the Companies**, Proceedings of 34th International Conference on Production Engineering-ICPE 2011, Niš, 2011. Page 159-162.
- P. Milosavljević, D. Živković, D. Milčić, **Possibility of Improving Maintenance Process in Heating Plants**, Proceedings of 15th Symposium on Thermal Engineering in Serbia SIMTERM 2011, Soko Banja, 2011. Page 519-528.
- P. Milosavljević, S. Mladenović, M. Jovanović, M. Todorović, **Improvement of Production Process and Providing Services in the Company „Hidrokontrol“ ltd. Niš**, International Journal „Total Quality Management & Excellence“, Vol. 38, No. 3, Page 179-186, 2010.
- P. Milosavljević, A. Milojević, D. Krstić, **Improvement of plastic coating and sheet metal treatment process in the company „Interlemind“ a.d. Leskovac**, Proceedings of International Conference: "Mechanical Engineering in XXI Century", Faculty of Mechanical Engineering, Niš, 2010. Page 225-228.
- P. Milosavljević, S. Ranđelović, G. Radoičić, **The possibilities for improvement of the maintenance process in the public utility service companies**, Proceedings of International Maintenance Conference & Exhibition: Euromaintenance 2010, Verona, Italy, 2010. Page 330-334.

E-mail: sassa@masfak.ni.ac.rs

Tel.: +381 (18) 500 627, 500 702



Personal data

- Ass. Prof. Saša S. Randelović was born in Niš, Serbia
- Graduated at the Faculty of Mechanical Engineering in Niš in 1992
- Finished his postgraduate studies at the Faculty of Mechanical Engineering in Niš in 1998
- Got his Ph.D. at the Faculty of Mechanical Engineering in Niš in 2006

Courses

Bachelor/master studies

- Cost management
- Integrated management systems
- Selected chapters from the section on informational production technologies and industrial management
- Metal forming process and FEM
- Risk management and product for six sigma

Doctoral studies

- Technology of Plasticity
- Advanced tools and methods for analyzing processes

Field of scientific work

- Metal forming technologies and non-linear FEM
- Processes management and tools of quality
- Product development based on the model 6σ

Selected published scientific papers

- Randelović S, Milosavljević P, Sommitsch C, Hot extrusion technology generation on the basis of FEM and FMEA analysis, **Strojarstvo**, vol. 52, No1, 2010, ISSN 0562-1887
- Krumphals F., Sherstnev P., Mitsche S., Randelovic S, Sommitsch C., "Physically Based Microstructure Modelling of AA6082 during Hot Extrusion", **Key Engineering Materials** (Vol. 424) pp. 27-34, 2009. doi:10.4028/www.scientific.net/KEM.424
- Randelović S., The new product development for mass customization on the base integrated process model, **Proceedings, 3rd International Conference on Mass Customization and Personalization in Central Europe**, Novi Sad, Serbia, pp. 149-153, 2008.
- Randelović S., Živanović S., CAD - CAM data transferring as a part of product life cycle, **FACTA UNIVERSITATIS, Series: Mechanical Engineering**, Vol. 1, 2007.
- Randelović S., Mladenović S., Milosavljević P., Modelling of forward extrusion process for hollow elements on base of nonlinear adaptive finite element method, **Journal for Technology of Plasticity**, Vol. 31, 1-2, 2006.
- Randelović S., Milosavljević P., Mladenović S., Production of aluminium structure with extrusion technology support QFD method, **Proceedings of Third International Working Conference "CIRP Total Quality Management - Advanced and Intelligent Approaches"**, Belgrade, 2005, (CD).
- Randelović S., Stoiljković V., Bogdanov Lj., Metal flow Modeling at the Forward Extrusion in the Shape Changing Area, **The 13th International DAAAM symposium Intelligent Manufacturing & Automation: Learning from Nature**, Viena, Austria, 2002.
- Randelović S., Stoiljković V., Analysis of Plastic Deformation on the Basis the Grain Microdeformation, **6th ICTP**, Nuremberg, Germany, 1999.
- Stoiljković V., Randelović S., Stoiljković B., Object oriented lathe processing simulation approach, **ESM'98 - 12th European simulation multicongress**, Manchester, Vol. II, 1998, pp. 37-39.

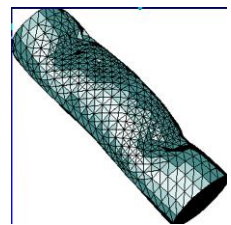
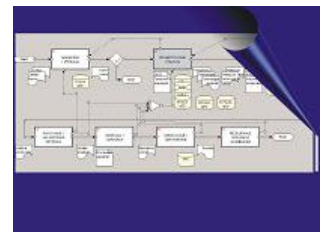
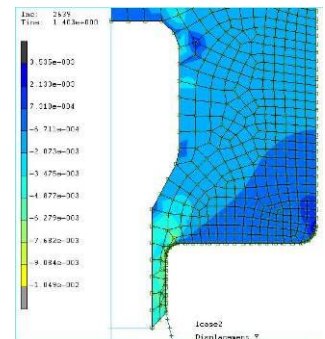

Predrag Lj. Janković, Ph.D., assistant professor

E-mail: jape@masfak.ni.ac.rs
Tel.: +381 (18) 500 625



Personal data

- Asst. Prof. Predrag Lj. Janković was born in Niš, Serbia
- Graduated at the Faculty of Mechanical Engineering in Niš in 1991
- Finished his postgraduate studies at the Faculty of Mechanical Engineering in Niš in 1998
- Got his Ph.D. at the Faculty of Mechanical Engineering in Niš in 2009

Courses

Bachelor/master studies

- Technical materials
- Measurement and control
- Cutting technologies
- Forming tools
- Ecologizing the manufacturing systems

Field of scientific work

- Contemporary materials
- Manufacturing technologies
- Measurement and control

Selected published scientific papers

- Janković P., Maksić M., Vukićević D., Kompozitni materijali i njihova primena u mašingradnji, **IMK-14, Istraživanje i razvoj**, No 2, 1996, str. 31-36.
- Vukićević D., Petković D., Blagojević P., Janković P., Armirano betonska noseća struktura prese-Matematičko modeliranje i način armiranja, **25. savetovanje proizvodnog mašinstva Jugoslavije**, Beograd, 1994.
- Blagojević P., Janković P., Metalna vlakna za ojačavanje kompozitnih materijala zasnovanim na cementu, **22. JUPITER Konferencija**, Beograd, 1996.
- Vukićević D., Ćirković B., Janković P., Neki rezultati primene novih tehnologija u mašingradnji s aspekta zaštite radne i životne sredine, **XXI Medjunarodno savetovanje o zaštiti životne i radne sredine**, Herceg Novi - Igalo, 1996.
- P. Janković, M. Radovanović, N. Vičovac., Essential Components of Abrasive Water Jet Cutting Machines, **Scientific Conference with International Participation "Manufacturing and Management in 21st Century"**, Ohrid, FYR Macedonia, 2004, pp. 100-105.
- Janković P., Radovanović M., Parameters of Abrasive Water Jet Cutting Process, **6th International Conference "Research and Development in Mechanical Industry"- RaDMI 2006**, Budva, Montenegro, 2006, pp. 343-346.
- Janković P., Radovanović M., Correlation of cutting data by abrasive water jet, **Annals of the Oradea University, Fascicle of Management and Technological Engineering**, Volume VII (XVII), 2008, ISSN 1583-0691, Oradea, Romania, 2008, pp. 1528-1533
- Janković P., Radovanović M., Experimental Investigation and Mathematical Modeling of Cutting Speed by Abrasive Water Jet, **The Sixth International Triennial Conference "Heavy Machinery - HM2008"**, Kraljevo, Serbia, 2008, pp. 29-32.
- Janković P., Radovanović M., Čiste tehnologije u funkciji ekologizacije proizvodnih procesa, **I konferencija "Održivi razvoj i klimatske promene"**, Univerzitet u Nišu, Mašinski fakultet, Niš, 2008, str. 155-159.

Dragan T. Mišić, Ph.D., assistant professor

E-mail: draganm@masfak.ni.ac.rs
Tel.: +381 (18) 500 669

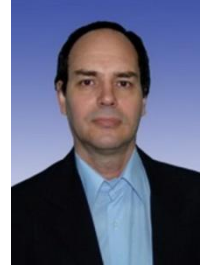

Personal data

- Asst. Prof. Dragan T. Mišić was born in Niš, Serbia
- Graduated at the Faculty of Mechanical Engineering in Niš in 1991
- Finished his postgraduate studies at the Faculty of Mechanical Engineering in Niš in 1998
- Got his Ph.D. at the Faculty of Mechanical Engineering in Niš in 2010

Courses

Bachelor/master studies

- Fundamentals of information and communications technologies
- Information systems
- Production processes management
- Selected chapters from the section on informational production technologies and industrial management
- Object oriented programming

Field of scientific work

- Application of information technologies in manufacturing
- Simultaneous design of technological processes
- Integration of CAD/CAPP/CAMM systems

Selected published scientific papers

- Manić M., Domazet D., Trajanović M., Mišić D., The Modelling Approach of Data and Knowledge Bases of Expert CAPP Systems, **32nd International MATADOR Conference**, Manchester, England, 1997., pp. 237-242.
- Manić M., Domazet D., Mišić M., Mišić D., Sistem za programiranje numerički upravljanih strugova CAMROT, **24. savetovanje proizvodnog mašinstva Jugoslavije**, Zbornik radova, , knjiga III, Novi Sad, 1992., str. 199-206.
- Manić M., Mišić D., Stojković M., Modeliranje oblika mašinskih delova orijentisano analizi tehnološkičnosti, **IRMES 2002**, Jahorina, Bosna i Hercegovina, 2002.
- Manić M., Stojković M., Mišić D., Đurišić Z., Manufacturability Analysis Using Feature Based Design, **International Conference on COMPUTER INTEGRATED MANUFACTURING, Advanced Design and Management**, Gliwice, Poland, 2003
- Mišić D., Manić M., Trajanović M., STEP standard - most između različitih CAD sistema, **IMK-14, Istraživanje i razvoj**, god. V, br. 10, 1999., str. 75-80.



Vladislav A. Blagojević, Ph.D., assistant professor

E-mail: vlada@masfak.ni.ac.rs
Tel.: +381 (18) 500 624



Personal data

- Asst. Prof. Vladislav A. Blagojević was born in Niš, Serbia
- Graduated at the Faculty of Mechanical Engineering in Niš in 1998
- Finished his postgraduate studies at the Faculty of Mechanical Engineering in Niš in 2004
- Got his Ph.D. at the Faculty of Technical Science in Novi Sad 2010

Courses

Bachelor/master studies

- Production systems
- Production automation
- Digital control systems
- Assembly technology
- Machine automation

Field of scientific work

- Energy efficiency
- Digital control systems
- Production automation and robotics

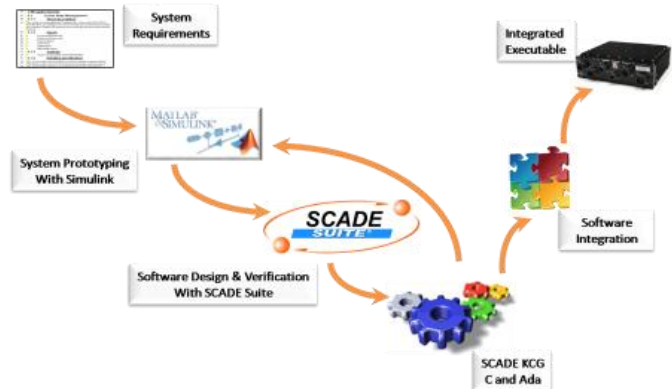

Selected published scientific papers

- Blagojević V., Stojiljković M., The expert system for computer-aided investigation of principal pneumatic diagrams of combinatory automates, **FACTA UNIVERSITATIS, Series: Mechanical Engineering**, Vol. 1, No 8, 2001, pp. 1049-1056.
- Blagojević V., Milosavljević Č., Application of digital sliding modes to synchronization of the work of two pneumatic cylinders, **FACTA UNIVERSITATIS, Series: Mechanical Engineering**, Vol. 1, No 9, 2002, pp. 1275-1285.
- Stojiljković M., Šešlija D., Blagojević V., HIPNEF Technologies in the Technological Processes Automation, **International Scientific Conference UNITECH'04**, Gabrovo, 2004, pp. II-215 - II-220 .
- Blagojević V., Stojiljković M., Dynamic Model of the Pneumatic actuator system, **Theoretical and Experimental Research of Elasto – Plastic Behaviour of Engineering Structures**, University of Niš, Niš, Serbia, 2006, pp. 261-266.
- Blagojević V., Stojiljković M., Mathematical Model of the Pneumatic system with Bridging of the Dual Action Cylinder Chambers, **IX Triennial International SAUM Conference on Systems, Automatic Control and Measurements**, Niš, Serbia, 2007, pp. 75-78.
- Blagojević V., Stojiljković M., Increasing energy efficiency of the execution part of pneumatic system by restoring energy, **FACTA UNIVERSITATIS, Series: Mechanical Engineering**, Vol. 6, No 1, 2008, pp. 37-44.
- Blagojević V., Šešlija D., Stojiljković M., Cost effectiveness of restoring energy in execution part of pneumatic system, **Journal of Scientific & Industrial Research**, Vol 70., No2, February 2011, pp. 170-176.
- Blagojević V., Stojiljković M., Nikolić V., Experimental Model for Energy Efficiency Examination of Pneumatic System, **Facta univesitaties Series: Electronics and Energetics**, Vo24., No1, April 2011, pp. 23-32.
- Blagojević V., Stojiljković M., Rančić M., DC servo motors cntrol of CNC machines by sliding mode, **34th International Conference on Production Engineering, Proceedings**, University of Niš, Faculty of Mechanical Engineering, Niš, Serbia, 28-30 September, 2011, pp. 377-380.
- Dudić S., Ignjatović I., Šešlija D., Blagojević V., Stojiljković M., Leakage quantification of compressed air using ultrasound and infrared thermography, **Measurement**, in press.

Miloš S. Stojković, Ph.D., assistant

E-mail: miloss@masfak.ni.ac.rs
 Tel.: +381 (18) 500 660

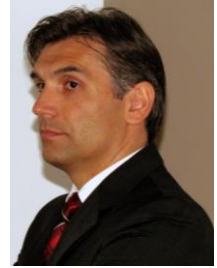

Personal data

- Miloš S. Stojković was born in Niš in 1972, Serbia
- Received B.Sc. in Mech. Engineering from the Uni. of Niš in 1996;
- Received M.Sc. in Technical Science from the Uni. of Niš in 2002;
- Received Ph.D. in Technical Science from the Uni. of Niš in 2011.
- Premium membership in MESA

Courses

Bachelor/master studies

- Production systems
- Manufacturing systems
- Programing of CNC machine tools (Siemens Sinumerik Certified Professional)
- CAPP/CAM systems

Field of scientific work

- Knowledge-based engineering systems (R&D in semantic networks and cognitive data processing models for CAD/CAM systems)
- Bioengineering
 - R&D in customized tissue scaffold design and fabrication;
 - R&D in CAD methods for reverse modeling of the human bones

Selected published scientific papers

- Stojkovic M., Milovanovic J., Vitkovic N., Trajanovic M., Arsic S., Mitkovic M. (2012), "Analysis of femoral trochanters morphology based on geometrical model", **JSIR-Journal of Scientific Industrial Research**, 71 (03), 210-216;
 - Milovanovic J., Stojkovic M., Trajanovic M., (2012), Book: **Sintering - Methods and Products**, Chapter IV: "Metal Laser Sintering For Rapid Tooling In Application To Tyre Tread Pattern Mould", InTech, ISBN 978-953-51-0371-4, 74-90;
 - Korunović N., Trajanović M., Stojković M., Mišić D., Milovanović J., (2011) *Finite Element Analysis of a Tire Steady Rolling on the Drum and Comparison with Experiment*, **Strojniški vestnik - Journal of Mechanical Engineering** 57 (12), 888-897;
 - Stojković M., Manić M., Trifunović M., Mišić D., (2011), "Semantic categorization of data by determining the similarities of associations of the semantic network", **E-Society Journal: research and applications**, 3(5), 3-13;
 - Stojkovic, M., Milovanovic, J., Vitkovic, N., Trajanovic, at al. (2010). „Reverse modeling and solid free-form fabrication of sternum implant“. **Australasian Physical & Engineering Sciences in Medicine**, 33 (3), 243-250;
 - Mišić, D., Stojković, M., Domazet, D., Trajanović, M., Manić, M., & Trifunović, M. (2010). „Exception detection in business process management systems“. **JSIR-Journal of Scientific and Industrial Research**, 69 (03), 1038-1042;
 - Arsić, S., Perić, P., Stojković, M., Ilić, D., Stojanović, M., Ajduković, Z., Vučić, S., (2010). „Comparative analysis of linear morphometric parameters of the humane mandibula obtained by direct and indirect measurement“, **Vojnosanitetski Pregled**, 67 (10), 839-846;
 - Manic, M., Miltenovic, V., Stojkovic, M., Banic, M., (2010). Feature Models in Virtual Product Development, **Strojišni vestnik**, 56 (3), 169-178;
 - Milovanovic, J., Stojkovic, M., Trajanovic, M., (2009). „Rapid Tooling of Tyre Tread Ring Mould Using Direct Metal Laser Sintering“, **JSIR-Journal of Scientific and Industrial Research**, 68(12), 1038-1042;
 - Stojkovic M., Manic M., Trajanovic M., (2005), „Knowledge-embedded template concept“, **CIRP - Journal of Manufacturing Systems**, 34 (1). 71-79.
-

Nikola D. Korunović, Ph.D., assistant

E-mail: nikola.korunovic@masfak.ni.ac.rs
Tel.: +381 (18) 500 660



Personal data

- Assistant Nikola D. Korunović was born in Niš, Serbia
- Graduated at the Faculty of Mechanical Engineering in Niš in 1995
- Finished his postgraduate studies at the Faculty of Mechanical Engineering in Niš in 2003
- Defended PhD thesis on FEA of rolling tires in 2011

Courses

Bachelor/master studies

- Application of FEM
- Computer aided products design
- CNC machine tools and robotics
- Fundamentals of information and communications technologies

Field of scientific work

- Analysis of behavior of automobile tires using the finite element method
- Application of finite element method - linear and nonlinear analysis

Selected published scientific papers

- N.Korunović, M.Trajanović, M.Stojković, Finite Element Analysis of a Tire Steady Rolling on the Drum and Comparison with Experiment, **Strojniški Vestnik - Journal of Mechanical Engineering**, Vol. 57, No 12, 2011, pp 888-897.
- Korunović N., Trajanović M., Stojković M., Vitković N., Trifunović M., Milovanović J., Tire tread modeling for FEA, **Proceedings of 34th International Conference on Production Engineering, ICPE 2011**, pp 209-212, September 28th – 30th, 2011, Niš, Serbia
- Korunović, N., Trajanović, M., Milovanović, J., Stojković, M., & Vitković N. (2010). Bone modelling for structural analysis using FEM. **Proceedings - International conference Mechanical Engineering in XXI Century MASING 2010**, Niš, Serbia, 205- 208.
- Trajanović, M., Korunović, N., Milovanović, J., Vitković, N., & Mitković, M. (2010). Primena računarskih modela samodinamizirajućeg unutrašnjeg fiksatora po Mitkoviću u saniranju trauma femura. **Facta universitatis - series: Mechanical Engineering**, 8(1), 27-38.
- Nikola Korunovic, Miroslav Trajanovic, Milos Stojkovic, Dragan T. Misic, Finite element model for parametric studies of tire geometry using steady state rolling analysis, **SEECM 2009, 2nd South-East European Conference on Computational Mechanics, An IACM-ECCOMAS Special Interest Conference**, Rhodes, Greece, 22–24 June 2009
- N.Korunovic, M.Trajanovic, M.Stojkovic, Finite Element Model For Steady-State Rolling Tire Analysis, **Journal of the Serbian Society for Computational Mechanics**, Vol 2, No 1, SDRM, 2008, pp 63-79
- N.Korunović, M.Trajanović, M.Stojković, FEA of tyres subjected to static loading, **Journal of the Serbian Society for Computational mechanics**, Vol. 1, No 1, SDRM, 2007, pp 87-98

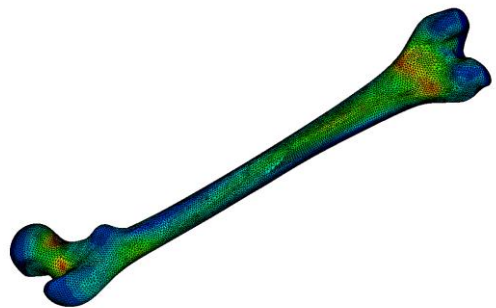
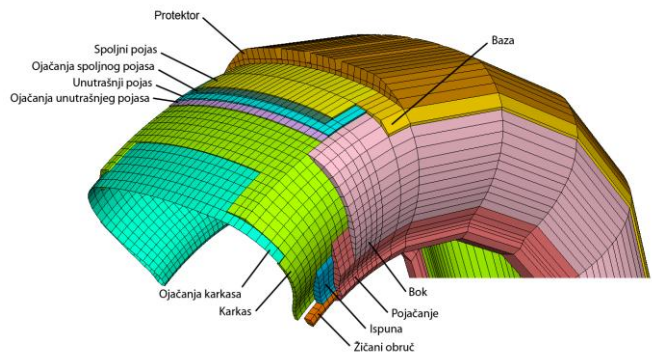

Jelena R. Milovanović, M.Sc., assistant

E-mail: jeki@masfak.ni.ac.rs
Tel.: +381 (18) 500 660



Personal data

- Assistant Jelena R. Milovanović was born in Niš, Serbia
- Graduated at the Faculty of Mechanical Engineering in Niš in 1998
- Finished his postgraduate studies at the Faculty of Mechanical Engineering in Niš in 2006

Courses

Bachelor/master studies

- Fundamentals of information and communications technologies
- Technical materials
- Selected chapters from the section on informational production technologies and industrial management
- Non-conventional machining
- Systems for rapid product development

Field of scientific work

- Application of rapid prototyping and rapid tooling technologies in the industry
- Application of rapid prototyping and rapid tooling technologies in medicine
- Reverse engineering

Selected published scientific papers

- J. Milovanovic, M. Stojkovic, M. Trajanovic, Rapid Tooling of Tyre Tread Ring Mould Using Direct Metal Laser Sintering, **JSIR**, Vol.68(12), December 2009, pp 1038-1042.
- J. Milovanović, M. Trajanović, Medical applications of rapid prototyping, **Facta Universitatis series Mechanical engineering**, Vol. 5, No. 1, 2007, pp. 79-85.
- J. Milovanovic, M. Stojkovic, M. Trajanovic, Possibilities of using selective laser melting for tire mold manufacturing, **Proceedings 2nd Intern. Conf. on Manufacturing Engineering ICMEN**, pp. 731-740, 2005.
- M. Stojkovic, M. Trajanovic, N. Vitkovic, J. Milovanovic, S. Arsic, M. Mitkovic, Referential Geometrical Entities for Reverse Modeling of Geometry of Femur, **VIPIMAGE 2009: ECCOMAS Thematic Conferences on Computational Vision and Medical Image Processing**, 14-16 Oct 2009, Porto, Portugal, P198.
- J. Milovanović, M. Trajanović, N.Vitković, M. Stojković, Rapid prototyping tehnologije i materijali za izradu implantata, **IMK 14 Istraživanje i razvoj**, 2009, pp 23-29.
- J. Milovanović, M. Trajanović, M. Stojković, Prednosti i nedostaci SLM tehnologije na primeru izrade alata za vulkanizaciju pneumatika, **31. Savetovanje proizvodnog mašinstva**, 2006.
- J. Milovanović, M. Trajanović, "Primena komercijalnih rapid prototyping tehnologija u industriji pneumatika", **IMK 14 Istraživanje i razvoj**, Kruševac, 2003.

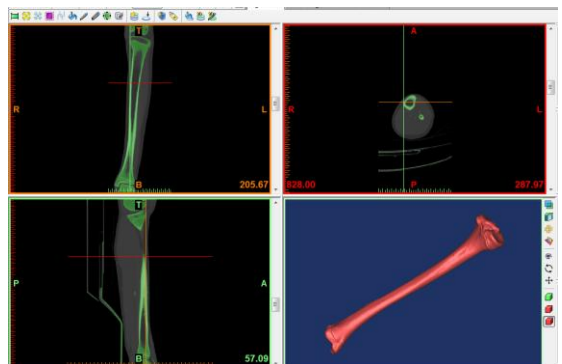

Milan M. Zdravković, Ph.D., assistant

E-mail: milan.zdravkovic@gmail.com
Tel.: +381 (18) 500 712



Personal data

- Assistant Milan M. Zdravković was born in Niš, Serbia
- Graduated at the Faculty of Mechanical Engineering in Niš in 1997
- Finished his postgraduate studies at the Faculty of Mechanical Engineering in Niš in 2007

Courses

Bachelor/master studies

- Fundamentals of information and communications technologies
- Information integration of organization
- E-business
- Selected chapters from the section on informational production technologies and industrial management

Field of scientific work

- Enterprise architectures, frameworks and models
- Semantic interoperability of systems
- Collaborative Networked Organizations

Selected published scientific papers

- Zdravković, M., Panetto, H., Trajanović, M., Aubrey, A. An approach for formalising the supply chain operations, **Enterprise Information Systems** 5 (4) (2011), 401-421
- M. Zdravković, M. Trajanović, Integrated Product Ontologies for Inter-Organizational Networks, **Computer Science and Information Systems**, 6 (2) (2009) 29-46
- Zdravković, M., Trajanović, M., Towards Semantic Interoperability Service Utilities. In: R. Meersman, T. Dillon, and P. Herrero (Eds.): **OTM 2011 Workshops, LNCS 7046**, pp. 39–48, 2011. © Springer-Verlag Berlin Heidelberg 2011
- Zdravković, M., Panetto, H., Trajanović, M., 2011, Local ontologies for semantic interoperability in supply chain networks, In: Zhang, R., Cordeiro, J., Li, X., Zhang, Z., Zhang, J. (Eds.), **Proceedings of the 13th International Conference on Enterprise Information Systems**. SciTePress, pp. 22-31
- Zdravkovic, M., Stojkovic, M., Mistic, D., Trajanovic, M. Towards Semantic Interoperability Framework for Custom Orthopaedic Implants Manufacturing. In: **Proceedings of 14th IFAC Symposium on Information Control Problems in Manufacturing (INCOM 2012)**
- Zdravković M., Trajanović M., Manić M., SOA-based approach to the Enterprise Resource Planning implementation in small enterprises, **FACTA UNIVERSITATIS, Series: Mechanical Engineering**, Vol.5, No.1, 2007, pp.97-104.
- Zdravković, M., Panetto, H., Trajanović, M., 2010, "Towards an approach for formalizing the supply chain operations", In: Paschke, A., Henze, N., Pellegrini, T. (Eds.), **Proceedings of the 6th International Conference on Semantic Systems**. I-SEMANTICS '10. ACM, New York, NY, USA

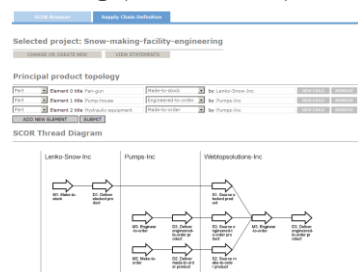
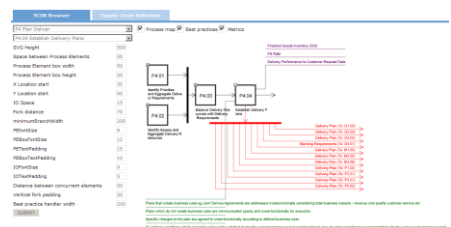

Dušan LJ. Petković, dipl.ing., assistant

E-mail: dulep@masfak.ni.ac.rs
Tel.: +381 (18) 500 624

**Personal data**

- Assistant Dušan Lj. Petković was born in Pirot, Serbia
- Graduated at the Faculty of Mechanical Engineering University of Niš in 2007
- PhD student at at the Faculty of Mechanical Engineering University of Niš

Courses

Bachelor/master studies

- Technical materials
- Engineering graphics
- Coating and surface hardening technology
- Welding technology 2

Field of scientific work

- Corrosion of stainless steels
- Electrochemical corrosion
- Acrylic resin materials in prosthetics
- Stainless steels in orthopedics

Selected published scientific papers

- Radenković G., Petković D., Uticaj korozijske sredine na brzinu korozijske čelika u betonu, **XI YUCORR**, Tara, 2009.
 - D. Petkovic, G. Radenkovic, **Fem Analysis of Influence Damage's Shape of Samples for SCC Tests to Stress State of The Samples**, Mechanical Engineering in XXI Century, The International Conference Niš, Serbia, November 25-26., 2010, pp. 217-221.
 - Dušan Petković, **Biorazgradivi materijali**, Održivi razvoj i klimatske promene SUSTAIN 2010, International conference, Nis, 2010, str. 174-179.
 - Predrag M. Živković, Dušan LJ. Petković, Mladen A. Tomić, Gradimir S. Ilić, Žarko M. Stevanović, Andrijana D. Stojanović, **Wind Energy Potentials On Stara Planina Mountain**, 15th Symposium on Thermal Science and Engineering of Serbia, Sokobanja, Serbia, October 18–21, 2011, pp. 325-332.
 - Goran Radenković, Dušan Petković, Vladislav Blagojević, **Influence of Heat Treatment on The SCC of Martensitic Stainless Steel**, Research and development of mechanical elements and systems, IRMES 2011, pp. 311-314.
 - M. Kostić, N. Krunic, Lj. Nikolić, V. Nikolić, S. Najman, I. Kostić, J. Rajković, M. Manić, D. Petković, **Ispitivanje mogućnosti redukcije količine rezidualnog monomera na kvalitet akrilatnih stomatoprotetskih materijala**, Hemijska industrija, 2011, vol. 65 ,no. 2, pp. 171-177.
 - Dušan Petković, Miroslav Radovanović, **Primena genetskog algoritma za optimizaciju obradnih procesa na primeru struganja**, IMK-14-Istraživanje i razvoj, 2011, vol. 17, br. 3, str. 11-16.
-

Nikola M. Vitković, dipl.ing., assistant

E-mail: vitko@masfak.ni.ac.rs
Tel.: +381 (18) 500 669

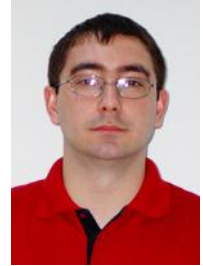

Personal data

- Assistant Nikola Vitković was born in Leskovac, Serbia
- Graduated at the Faculty of Mechanical Engineering in Niš in 2001

Courses

Bachelor/master studies

- Fundamentals of information and communications technologies
- Manufacturing technologies
- Fundamentals of computer graphics and programming
- Reverse engineering and systems for rapid product development
- Selected chapters from the section on informational production technologies and industrial management

Field of scientific work

- Application of reverse engineering techniques in information and manufacturing technologies
- Application of reverse engineering techniques in medicine
- Development of software applications using modern information technologies
- Artificial Intelligence and its application
- Freeform surface modelling and applied mathematics

Selected published scientific papers

- Stojković M., Milovanović J., Vitković N., Trajanović M., Arsić S., Mitković M., Analysis of femoral trochanters morphology based on geometrical model, **Journal of scientific & industrial research**, vol. 71, br. 3, str. 210-216, 2012.
- Stojković M., Milovanović J., Vitković N., Trajanović M., Grujović N., et al., Reverse modeling and solid free-form fabrication of sternum implant, **Australasian Physical & Engineering Science in Medicine**, Vol. 33, Number 3, Pages 243-250, 2010
- Vitković N., Milovanović J., Trajanović M., Korunović N., Stojković M., Manić M., Methods for creating geometrical model of femur anatomical axis, **34th International conference on production engineering**, September 28th – 30th, 2011, Niš, Serbia.
- Vitković N., Trajanović M., Milovanović J., Korunović N., Arsić S., Ilić D., The geometrical models of the human femur and its usage in application for preoperative planning in orthopedics, **ICIST 2011**, March 7th – 8th, 2011, Kopaonik, Serbia,
- Trajanović M., Korunović N., Milovanović J., Vitković N., Mitković, M., Primena računarskih modela samodinamizirajućeg unutrašnjeg fiksatora po Mitkoviću u saniranju trauma femura. **Facta universitatis - series: Mechanical Engineering**, 8(1), 27-38., 2010
- Korunović N, Trajanović M., Milovanović J., Stojković M., Vitković N., Bone modelling for structural analysis using FEM, **The International Conference "Mechanical Engineering in XXI Century"**, 25.-26.11.2010., Nis, Serbia
- Trajanovic M., Vitkovic N., Stojkovic M., Manic M., Arsic S., The morphological approach to geometrical modelling of the distal femur, **SEECM 2009, 2nd South-East European Conference on Computational Mechanics**, Rhodes, Greece, 2009.

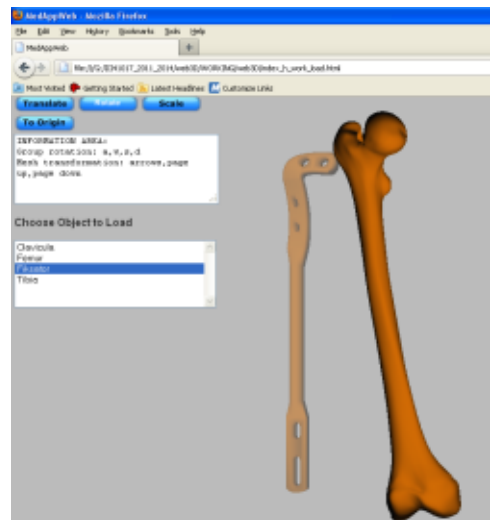

Milan B. Trifunović, dipl.ing., assistant

E-mail: milant@masfak.ni.ac.rs

Tel: +381 (18) 500 657

Personal data

- Assistant Milan Trifunović was born in Niš, Serbia
- Graduated at the Faculty of Mechanical Engineering in Niš in 2003

Courses

Bachelor/master studies

- Fundamentals of information and communications technologies
- Manufacturing technologies
- Technological processes planning
- Programing of CNC machine tools (Siemens Sinumerik Certified Professional)
- Information technologies 1
- Information technologies 2

Field of scientific work

- Planning of production processes
- Application of information technologies in manufacturing
- Artificial Intelligence

Selected published scientific papers

- Vitković N., Mišić D., Manić M., Trajanović M., Trifunović M., The fuzzy expert system for the selection of optimal scanning method, **Metalurgia International**, 2012, Vol. 17, No. 8, pp. 62-66
 - Trifunović M., Milovanović J., Trajanović M., Korunović N., Stojković M., Approaches to automated creation of tissue engineering scaffolds, **34th International Conference on Production Engineering, ICPE 2011**, September 28th – 30th, 2011, Niš, Serbia
 - Stojković M., Manić M., Trifunović M., Vitković N., Semantic interpretation of the product model features in product quality assessment, **Sixth International Working Conference "Total Quality Management – Advanced and Intelligent Approaches", IWC TQM 2011**, June 6th – 10th, 2011, Belgrade, Serbia
 - Stojković M., Manić M., Trifunović M., Mišić D., Semantička kategorizacija podataka utvrđivanjem sličnosti asocijacija semantičke mreže, **1st International Conference on Information Society Technology and Management, ICIST 2011**, March 7th – 8th, 2011, Kopaonik, Serbia
 - Manić M., Stojković M., Trifunović M., Semantic Features in Computer Aided Manufacturing Systems, **The International Conference "Mechanical Engineering in XXI Century"**, November 25th – 26th, 2010, Niš, Serbia
 - Mišić D., Stojković M., Domazet D., Trajanović M., Manić M., Trifunović M., Exception Detection in Business Process Management Systems, **Journal of Scientific and Industrial Research**, 2010, Vol. 69, No. 3, pp. 188-193
 - Stojković M., Manić M., Trifunović M., Mišić D., Semantic Interpretation of Geometrical Features, **International Journal "Total quality management & excellence"**, 2009, Vol. 37, No. 3, pp. 75-80
 - Stojković M., Manić M., Trifunović M., Mišić D., Prepoznavanje tehničkih elemenata CAD modela analizom njihovih značenjskih odlika, **YU INFO 2009**, March 8th - 11th, 2009, Kopaonik, Serbia
-

Printed publications

- Pavlović A.: **Osnovi teorije planiranja eksperimenta**. Mašinski fakultet u Nišu, 1980, str. 71.
- Stoiljković V.: **Teorija obrade deformisanjem**. Mašinski fakultet, Niš, 1984, str. 654.
- Domazet D., Trajanović M., Manić M.: **Uvod u računarski integrisane proizvodne sisteme**. Naučna knjiga, Beograd, 1989, str. 375.
- Domazet D.: **Programiranje računarske grafike pomoću GKS sistema**. Naučna knjiga, Beograd, 1989, str. 309.
- Đukić H., Popović P.: **Obrada deformisanjem**, Mašinski fakultet. Mostar, 1988, str. 420.
- Popović P.: **Mašine za obradu deformisanjem, I deo. Klasifikacijska, konceptijska i eksploatacijska analiza**. Univerzitet u Nišu, Niš, 1991, str. 210.
- Popović P., Temeljkovski D.: **Mašine za obradu deformisanjem, II deo. Noseće strukture**. Univerzitet u Nišu, Niš, 1991, str. 257.
- Marinković V.: **MAŠINSKA OBRADA, I deo. Zbirka zadataka iz obrade materijala deformisanjem**, Mašinski fakultet, Niš, 1990, str. 274.
- Marinković V.: **MAŠINSKA OBRADA, II deo. Zbirka zadataka iz obrade materijala rezanjem**, Mašinski fakultet, Niš, 1990, str. 251.
- Lazarević D., Radovanović M.: **Nekonvencionalne metode - Obrada materijala odnošenjem**. Mašinski fakultet, Niš, 1994, str. 264.
- Vukićević D.: **Mašinski materijali**. Univerzitet u Nišu, Niš, 1994, str. 341.
- Marinković V., Radovanović M.: **Priručnik za laboratorijske vežbe iz obrade materijala rezanjem**. Mašinski fakultet, Niš, 1994, str. 220.
- Marinković V.: **Deformaciono ojačavanje materijala u procesima obrade deformisanjem u hladnom i toplom stanju**. Monografija, Mašinski fakultet, Niš, 1995, str. 268.
- Stoiljković V.: **Quality tools – alati kvaliteta**. CIM College, Mašinski fakultet, Niš, 1996, str. 258.
- Stoiljković V., Veljković B., Stoiljković P., Jevremović D.: **Promenama do svetske klase, poboljšanje i reinženjering procesa**. CIM College, Mašinski fakultet, Niš, 1998, str. 346.
- Đorđević Lj., Popović P.: **Tehnologija mašinogradnje - Tehnologija plastičnosti**. Mašinski fakultet, Kraljevo, 1988, str. 266.
- Manić M., Spasić D.: **Numerički upravljane mašine**. Mašinski fakultet, Niš, 1998, str. 257.
- Rančić B.: **Praktikum za laboratorijske vežbe iz inženjerske metrologije sa teorijskim osnovama**. Mašinski fakultet, Niš, 1999, str. 187.
- Milosavljević P.: **Održavanje alatnih mašina - tehnički vek i ciklusi**. Monografija, Biblioteka Academia, Zadužbina Andrejević, Beograd, 1999, str. 125.
- Lazarević D.: **Rotaciono izvlačenje cilindričnih i koničnih delova**. Monografija, Mašinski fakultet, Niš, 2000, str. 147.
- Temeljkovski D.: **Zavojne prese sa varijabilnim momentom inercije zamajca**. Monografija, Zadužbina Andrejević, Beograd, 2000, str. 88.
- Radovanović M.: **Tehnologija mašinogradnje - Obrada rezanjem**, Mašinski fakultet, Niš, 2002, str. 328.
- Stoiljković M.: **Logička sinteza pneumatskog upravljanja**. Monografija, drugo izdanje, Mašinski fakultet, Niš 2002, str. 376.
- Rančić B.: **Sistemi za merenje, prikupljanje i obradu podataka, I deo**. Mašinski fakultet, Niš, 2005, str. 190.
- Rančić B.: **Oblikovanje delova od lima nestišljivim fluidom**. Monografija. Mašinski fakultet, Niš, 2005, str. 120.
- Stoiljković V., Stoiljković P., Stoiljković B., Obradović Z.: **Integrirani sistemi menadžmenta ISO 9001:2000, ISO 14001:2004 i OHSAS 18001:1999**. CIM College, Mašinski fakultet, Niš, 2006, str. 525.

- Kostogrizov A., Stoilković V.: **Applicable Methods to Analyze and Optimize Standard System Processes**. Armament. Policy. Conversion, Moscow, 2007, pages 335.
 - Milosavljević P.: **Održavanje tehničkih sistema po konceptu TPM i Six Sigma**. Monografija, Biblioteka Dissertatio, Zadužbina Andrejević, Beograd, 2007, str. 111.
 - Trajanović M., Grujović N., Milovanović J., Milivojević B.: **Računarski podržane brze proizvodne tehnologije**. Monografija, Mašinski fakultet , Kragujevac, 2008, str. 188.
-

Selected scientific projects

National projects

- **Razvoj teorije i savremenih metoda projektovanja i proračuna sredstava za obradu deformisanjem sa aplikacijom.** Rukovodilac: P. Popović, Realizator: Mašinski fakultet Niš . Finsnsijka podrška: Republička zajednica nauke Srbije, EI Niš, MIN Niš, 1974-1976.
- **Istraživanje i razvoj metoda proračuna savremenih sredstava i metoda obrade materijala deformisanjem sa ispitivanjem obradivosti domaćih materijala, zaključno do verifikacije u eksploataciji.** Rukovodilac: P. Popović, Finsnsijka podrška: Republička zajednica nauke Srbije, EI Niš, MIN Niš, Zavodi "Crvena Zastava" Kragujevac, Kombinat "Smederevo" Smederevo i dr., 1978-1980.
- **Analiza principijelnog rešenja NC-mašina za probijanje i prosecanje.** Rukovodilac: M. Stojiljković, Finansijka podrška: Osnovna zajednica nauke Regiona Niš, 1979.
- **Istraživanje i razvijanje energetskih komponenti pogonskog mehanizma zavojnih presa.** Rukovodilac: P. Popović, Finansijka podrška: Osnovna zajednica nauke Regiona Niš, 1979-1980.
- **Razvoj, istraživanje i projektovanje novih pogonskih sistema elektro zavojnih presa sa programskim upravljanjem i aplikacijom od 1.000 do 10.000 kN.** Rukovodilac: A. Pavlović, Finansijka podrška: Osnovna zajednica nauke Regiona Niš, 1982-1985.
- **Fleksibilni proizvodni sistemi.** Rukovodilac: P. Popović, Finansijka podrška: Republička zajednica nauke Srbije i MIN Niš, 1988-1990.
- **CIMROT: Računarski podržano projektovanje i izrada rotacionih delova.** Rukovodilac: D. Domazet, Finansijka podrška: Ministarstvo nauke i tehnologije Republike Srbije, 1988–1994.
- **Istraživanje inženjerskih metoda proračuna alata za istosmerno istiskivanje Al-legura.** Rukovodilac: P. Popović. Finansijka podrška: Republički fond za tehnološki razvoj Srbije i "NISSAL" Niš, 1991-1993.
- **Istraživanje i razvoj sistema za izradu lanaca sa karikama kontinualnim livenjem.** Rukovodilac: D. Vukićević, Finansijka podrška: Ministarstvo nauke i tehnologije Republike Srbije, 1994–1996.
- **CIM modeli za upravljanje poslovno-proizvodnim sistemima i njihov transfer ka drugim granama industrije,** Podprojekat - Pp12: CIM koncept DP NITEX Niš. Rukovodilac: V. Stoilković, Finansijka podrška: Ministarstvo za nauku Republike Srbije, 1994-1998.
- **Razvoj informacionog sistema za planiranje, upravljanje i nadzor proizvodnih i poslovnih sistema.** Rukovodilac: V. Stoilković, Finansijka podrška: Ministarstvo za nauku Republike Srbije, 2001-2003.
- **Razvoj softvera za poboljšanje performanse industrijskih procesa.** Rukovodilac: V. Stoilković, Finansiran podrška: Ministarstvo za nauku Republike Srbije, 2002-2003.
- **Metodi projektovanja i optimizacije konstrukcije novog staklenika za industrijsku proizvodnju.** Koordinator: V. Marinković, Finansijka podrška: Ministarstvo za nauku Republike Srbije, 2002-2003.
- **Primenljive tehnologije izrade otkovaka sa aspekta uštede materijala i energije za primenu u mašinstvu.** Rukovodilac: V. Marinković, Finansijka podrška: Ministarstvo za nauku Republike Srbije, 2002-2004.
- **Računarski podržan razvoj pneumatika.** Rukovodilac: M. Trajanović, Finansijaka podrška: Ministarstvo nauke i tehnologije Republike Srbije, 2002-2004.
- **Razvoj nove generacije energetski efikasne građevinske stolarije sa drvenim, aluminijumskim i aluminijum-drvo ramovima.** Koordinator: D. Lazarević, Finansijka podrška: Ministarstvo za nauku Republike Srbije, 2003-2004.
- **Razvoj softvera za integrisane sisteme menadžmenta.** Rukovodilac: V. Stoilković, Finansijka podrška: Ministarstvo za nauku Republike Srbije, 2005-2007.

- **Planiranje, terminiranje i adaptibilno upavljanje proizvodnim procesima.** Rukovodilac: M. Manić, Finansijska podrška: Ministarstva za nauku Republike Srbije, 2005-2008.
- **Modeliranje korelacija parametara procesa rezanja plazmom metodama veštačke inteligencije.** Rukovodilac: D. Lazarević, Finansijska podrška: Ministarstvo za nauku Republike Srbije, 2008-2010.
- **Aktivni semantički model podataka o proizvodu-12010.** Rukovodilac: M. Manić, Finansijska podrška: Ministarstvo za nauku Republike Srbije, 2008-2010.
- **Primena IT u hirurgiji koštano-zglobnog sistema, TR12012,** Ministarstvo za nauku i tehnološki razvoj republike Srbije, 2008-2010

International projects

- **PIKS: Product Information and Knowledge Servers for Concurrent Engineering Environments.** Rukovodilac: D. Domazet, Finansijska podrška: Nanyang University, Singapore 1994–1997.
- **Advanced Database Technologies for Concurrent Engineering.** Rukovodilac: D. Domazet, Finansijska podrška: Nanyang University, Singapore, 1997–2001.
- **The Feasibility Study for PDM Implementation.** Rukovodilac: D. Domazet Finansijska podrška: Singapore Technologies Aerospace, 1999.
- **Mould Development Re-Engineering Feasibility Study For Productivity Improvement.** Rukovodilac: D. Domazet, Finansijska podrška: Kojin Mould Manufacturing Pte Ltd., 1999.
- **WEB-MOB - Development Of Researchers Mobility Policy Guidelines for the Region of Western Balkans, FP6.** Rukovodilac: M. Trajanović, Finansijska podrška: European Commission, 2005-2006.
- **WEB-ENV - Development of environmental guidelines for the region of Western Balkans, FP6.** Rukovodilac: M. Trajanović, Finansijska podrška: European Commission, 2005-2007.
- **Unconventional and Hybrid Unconventional Processes and Production Technologies.** Koordinator: M. Radovanović, Finansijska podrška: CEEPUS, Sofia, Bulgaria, 2007-2009.
- **SER-MORE - Development of Serbian Network of Mobility Centers, FP7.** Rukovodilac: M. Trajanović, Finansijska podrška: European Commission, 2008-2010.
- **Inter-sectoral Mobility of Researchers in South-Eastern Europe (I-SEEMob).** Koordinator: M. Trajanović, Finansijska podrška: European Commission - FP7 programme, 2009-2011.

Data on former members of the Department

Aleksandar D. Pavlović, Ph.D., full professor

Dr Pavlović was born in Belgrade on June 14th 1922, where he finished high school in 1940 and in academic year 1940/1941 he enrolled at Technological Faculty – Department of Mechanical Engineering of the University of Belgrade. He paused his studies during the War, from November 20th 1944 he was in National Army, so he continued his studies in 1945 and he graduated in July 1950 on the subject Machine tools with the average grade 8,99.

After he graduated he worked at the design office of the Ministry of Ferrous Metallurgy, and from 1951 till 1972 in the machine production company „Ivo Lola Ribar – ILR" in Železnik.



During 22 years of work in the economy he has passed the way from the designer of Machine tools to the Director of the Development Sector (later on, the Institute for designing and construction). In the same time, he was working part-time at the Faculty of Mechanical Engineering in Belgrade from 1951 till 1958 as the assistant for the course Machine tools.

Participating in the development of the ILR factory, he worked on the designing the Machine tools for processing by forming until 1954, then on designing machines for processing by cutting, and from 1965 he worked on machines with program work and numerically controlled.

During his work at the ILR factory he had a chance to get familiar with many European factories for Machine tools, as the director of development sector he participated in the creation of the production program that has developed successfully and is sustainable, in 1965 he was in the USA for several months for his specialized studies in the factories of Machine tools, and in 1964 he was a technical delegate in the „Invest-Import" factory in Delhi, India, as well as supervising engineer during assembly of designed industrial facilities in Sudan.

On the basis of earlier successful actions in the field of tools design work and achievements, as well as the previous teaching experience gained while working many years as a teaching assistant of late prof. Pavle Stanković at the course Tools Machine at the Faculty of Mechanical Engineering in Belgrade, on May 1st 1972 he is elected for assistant professor at Faculty of Mechanical Engineering in Niš, where he was a successful teacher at the Department for Production Engineering on the courses Technological systems and Machine tools. In these positions dr Pavlović has shown, in addition to proven capability and qualification for professional development and research, skills for teaching and the art to bind listener's attention to presented materials and the capability to transfer his knowledge to his students. After he defended his doctoral thesis in April 1975 and having in mind how successful he was in teaching and his activities in course of Metrology, and also in implementation and organization of scientific research activities, he was promoted to associate professor for he course Machines for processing by cutting at the Faculty of Mechanical Engineering in Niš in 1976, and, some time later, to a full professor in 1981.

During his work at Faculty of Mechanical Engineering in Niš prof. Aleksandar Pavlović was a member of the Council of the Faculty and member of many different commissions. Prof. Aleksandar Pavlović was also once elected Dean for Academic Affairs at Faculty of Mechanical Engineering, and from 1980 till 1982 he was the Chief of the Department for Production Engineering.

Predrag Popović, Ph.D., full professor

Dr Predrag Popović, a full professor, the honored member – adviser of AINSCG since 2004, was born on November 11th 1927 in Belgrade. He began his studies in Prague, but continued them in 1948 at Faculty of Mechanical Engineering in Belgrade, Department for Aviation, where he graduates in 1955. He got his Ph.D. in 1972, in the field of technical sciences, profile Machines for processing by forming at the Faculty of Mechanical Engineering in Niš. He works in company „Soko“ from 1956 till 1961 in aircraft design technology. During that period he participated in designing and manufacturing of prototype of national airplane „Galeb“, as structural engineer and chief engineer. From 1961 till 1963 he works at the company "Krušik" – in Valjevo, where he works in specific production as the chief constructor, and from 1963 till 1966 he works at the company "Ivo Lola Ribar" – in Železnik, in Design office as an adviser-designer for designing machines for processing by forming. In October 1966 he was elected for assistant professor at the Department for mechanical engineering at Technical Faculty in Niš for the course " Processing and Machine tools", in 1971 he becomes associate professor, and in 1975 a full professor. In 1974 he was also elected associate professor and in 1975 a full professor at the Faculty of Forestry in Belgrade. After he started working at the Faculty, prof. Popović establishes and creates activities at the Department for Production Engineering, oriented at processing materials by forming. He also establishes two laboratories – the first one for processing and Machine tools and the second one for materials in mechanical engineering. He was the chief of the department since its founding up till the moment he got retired. During that period he conducted numerous changes in the teaching process. The most notable thing he did in that field was his contribution to making plans and implementing programs for second degree studies and postgraduate studies in the profile Processing by forming. At the same time, he is one of the organizers, founders and producers of scientific research activities in this important field. Prof. Popović was giving special attention to educating young academic staff, so it has to be taken for granted that the Department for Production Engineering in the last few decades is one of the strongest personnel in the country in the field of processing by forming. It can be said without mistake that prof. Popović stands out by his remarkable work on educating young people in the field of processing by forming – not only at Faculty of Mechanical Engineering in Niš, because his work in educating young people is remarkable also in the field of reshaping materials by plastic in Novi Sad, Mostar, Banja Luka, Podgorica and Kragujevac. This could be easily proved by mentioning that he has been member of commission for assessing 23 doctoral dissertations.

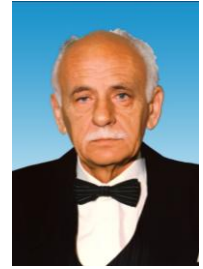

Permanent verification of scientific work of prof. Popović front of the home and foreign scientific and professional public is recognized in over 180 published papers in scientific and professional publications in the country and abroad, where dozens of its bibliographic items were cited in books and works of local and foreign authors.

He is the editor in chief for the magazine "IMK 14 – Research and development", also a member of editorial for the magazine "Journal for Technology of Plasticity" whose editor in chief he was in 1977 and 1978. He was the chief of the editorial board since 1975 when the magazine „Instruments and methods of processing by forming“ of the Department for Production Engineering at the Faculty of Mechanical Engineering in Niš.

He was the member of the management authorities of the Faculty and the University. These are some notable functions he was elected to: The first dean of the Faculty of Mechanical Engineering in Niš from 1971 until 1973, the Faculty Council President form 1973 until 1975, and from 2004 until 2006.

Scientific work of prof. Popović represent prominent and notable studies and scientific contribution, especially in the field of machines and new technologies in processing by forming, meaning that these are great contribution to science development in the field of production mechanical engineering. This work of his at the Faculty was, at the same time, in constant relation to many production organizations, faculties and institutes, which has created conditions for Faculty of Mechanical Engineering to become significant institution for academic activities in this field.

The longtime work of Prof. Predrag Popović has given the development of the Faculty of Mechanical Engineering notable and prominent contribution in the field of processing by forming. By doing that, he succeeded in consolidating the work in managing and controlling, in profession and science and in educating professional and scientific stuff, so it can easily be said that he is one of the most important names and doyen in the field of production mechanical engineering and high education.

Ljubomir Janković, Ph.D., full professor

Dr Ljubomir Janković is a full professor at the Faculty of Mechanical Engineering in Niš. He was born on May 11th 1933 in Niš where he finished elementary and high school, and the Department for Mechanical Engineering at Technical school. Since 1951 he works as a mechanical technician at „Zavodi RR“ in Niš. After he graduated at Faculty of Mechanical Engineering in Belgrade, he has work on the following positions at Electronic Industry:

- Design of tools and devices,
- Developing and production of electromechanical component parts,
- Manager of the Company for production of electromechanical component parts and tool room within the Electronical Industry in Niš



Alongside with his engagements in the economy, he was working at the Technical school (high education institution). He worked at the Department for Mechanical Engineering at the Technological Faculty in Niš from 1965 as an assistant on the following courses: Basis of mechanical engineering, Technical drawing, and since 1981 on the course Designing of tools.

In 1997 he was elected a full professor at the Faculty of Mechanical Engineering in Niš.

During his teaching he was using current knowledge in the field of processing by forming and designing of tools which he acquired during his work in the economy and on the basis of his own research. He was trying to draw his students' attention on modern way of computer aided designing tools and technologies of producing tools, to achieve coupling and integration of CAD and CAM systems.

In the activities of the Institute of Faculty of Mechanical Engineering in the field of scientific research and cooperation with industry, he participated in the research in a number of scientific-research projects. He has published dozens of scientific papers.

Alongside with participating in teaching and scientific research, he was managing the creation of master's and doctoral theses. He was a mentor for three doctoral and four master's theses.

Until his retirement in 2001, 470 students has graduated (five-year studies) with prof. Ljubomir Janković.

For his extraordinary contribution to the development of the faculty, the Council of Faculty of Mechanical Engineering has awarded him with: Charter (1980), Silver medal (1985) and Golden medal (1990). He is a winner of May Day Award of Chamber of Commerce in Niš for remarkable results in improvement and development of industry.

Dušanka R. Vukićević, Ph.D., full professor

Professor Dušanka M. Vukićević, dipl.ing. in metallurgy, was born in Drenac in Serbia on January 10th 1937.

She finished elementary school "Učitelj Tasa" in Niš, and she finished high school "Stevan Sremac" in Niš in 1957.

In academic year 1959/60 she enrolled at the Faculty for Technology and Metallurgy in Belgrade, where she graduated on November 3rd 1965. She got her B.A. at the Department for Metallurgy, Chair for Processing of Metals in the Plastic State. She got her M.Sc. in April 1977, at Electronical Engineering Faculty in Niš, the Department for materials. She defended her doctoral thesis in March 1983 at the Faculty of Mechanical Engineering in Belgrade.



After her graduation, she got a job at the non-ferrous metal industry "Đuro Salaj" in Niš, where she worked on solving the problems of developing methods for microscopic and mechanical testing of non-ferrous metals, materials of tools and testing of product quality. After spending three years at the same organization, she got promoted to Chief of Technological and Construction Department, where she worked on: current technologies, technologies of production and organization of production, thermal processing and designing of the tools for processing by forming, as well as on the development of new alloys.

In October 1969, she was elected an assistant at the Technological Faculty in Niš, Department for Mechanical Engineering, at the course "Technology of Materials", and after that, starting June 1985, she was elected an assistant professor, associate professor and full professor at the Faculty of Mechanical Engineering in Niš, at the course "Materials in mechanical engineering".

Since 1989 up to her retirement she was the Chief of Laboratory for materials in mechanical engineering at Faculty of Mechanical Engineering in Niš.

Since 1986, she was teaching at the third-degree master studies, course „materials for the special purpose“, and from 1991 the following courses: „Contemporary materials in mechanical engineering“, „Composite materials“ and „Thermal processing of tool materials“.

She participated in a great number of doctoral or master's theses as a mentor or a member of Board.

She wrote several books and practicums in the field of materials in mechanical engineering, she published prominent scientific papers in the country and abroad and she participated in many scientific-expert congresses. She managed or participated in many significant projects financed by different foundations and Ministry of Science of former Yugoslavia.

Vojislav R. Stoiljković, Ph.D., full professor

Dr Vojislav R. Stoiljković, full professor at Faculty of Mechanical Engineering in Niš was born on May 21, 1945. He graduated from high school in 1964 as the best student in his class and as a scholar of EI (Electronic Industry) Niš. From 1964 until 1966 he works in Electronic Industry Niš, while at the same time finishes his first year of studies as an extramural student at Faculty of Mechanical Engineering in Niš. He finishes his first year with GPA 9 and enrolls the second year as a full-time student. In 1969 he graduates from the faculty as the best student in the class with GPA 9,47.



Around that time Electronic Industry Niš and Faculty of Mechanical Engineering reach an agreement – 1/3 of his business hours he will be working for the company and the rest of it at the faculty. During 1972/1973 he was on military service (Reserve Officers School). He finishes his service as the best among 180 students.

He got his master's degree in 1974 at Faculty of Mechanical Engineering in Belgrade. His mentor was professor Vladimir Šolaja and the subject was New Technologies in Forming Sheet Metal. He got his PhD in April 1977 at Faculty of Mechanical Engineering in Niš, his mentor was professor Predrag Popovic, the subject - New Technologies in Forming Sheet Metal with Incompressible Fluid. He was elected assistant professor in 1978 at Faculty of Mechanical Engineering in Niš. In 1987, at the same faculty, he was elected a full professor.

In 1978 he implements the project for production of „Precipitation electrode of electrostatic filter“ for the power plant Obrenovac. From 1978 until 1982 he works as director of the Institute for Mechanical Engineering on Faculty of Mechanical Engineering in Niš. He cooperates intensively with the economy and realizes a large number of different projects. For Yugoslav Army he designs a 185mm diameter sphere in which gas is compressed at 320 bar and is used for controlling missiles and rocket launcher barrel made from sheet metal for "Oganj" and "Orkan". He realized over 15 science projects for the Ministry of Science.

Dr Vojislav R. Stoiljković has published over 200 scientific papers in Serbia and abroad. He has published 14 books, one of which in English with professor Kostigrizov in Moscow. He is a member of ISO committee for standard development in software. He is a senior member of ASQ in the United States.

During 1990 he was a visiting professor in West Germany for the CIM course - Computer integrated Manufacturing. In 1991 he begins with the education of managers and consulting for CIM systems and ISO management systems. In 1997 he begins to study and implement TQL concept which was developed by the US navy for leader training in progressive companies in Serbia. Since 2000 he begins to hold seminars for Six Sigma and continues to track new concepts in management. He points out the importance of developing new methods and tools of quality for improving processes and achieving the excellence. He develops all the necessary quality tools for Lean Six Sigma. From 2004 onwards he trains experts of foreign companies in Serbia for Lean Six Sigma concept. He implements Lean Six Sigma concepts in Serbia, Romania, Czech Republic and Slovenia for foreign companies. He implements Lean Six Sigma concepts for reduction of energy losses for company „Jugoistok“ and EPS. In 2007 he comprises a study for transformation towards the Lean Six Sigma organization for Belgrade Airport.

He introduces new courses at Faculty of Mechanical Engineering in Niš: Cost management, SPC, Integrated management systems, Management in Mechanical Engineering, Lean Enterprise, TQL – Total Quality Management. He was the chairman of the Department of Production Engineering from 1993 until 2001.

Dragan D. Domazet, Ph.D., full professor

He was born on July 5, 1947 in Niš. He finished elementary school „Ucitelj Tasa“ in Niš and Primary Music School in Niš (piano). He graduated from the Mathematics Department of the high school „Stevan Sremac“ in Niš in 1966, when he received „Mihajlo Petrovic Alas“ diploma. He graduated from Department of Production Engineering of the Faculty of Technical Science in Niš in 1971. At the same faculty he got his master's degree in 1976 and his PhD in 1981. Since 1971 he works as assistant at Faculty of Mechanical Engineering in Niš; in 1981 he was elected assistant professor, in 1987 associate professor and in 1991 full professor at Faculty of Mechanical Engineering in Niš. He was teaching at the Department for Production Engineering - undergraduate and postgraduate studies. He has worked on numerous scientific and industrial projects, and from 1978 until 1990 he was working as an associate at Electronic Computer Center EI Niš. He has published approximately one hundred scientific and professional papers and two books. During the academic year 1990-91 he was at the University of Illinois, Urbana, US, where he was working on research in the field of artificial intelligence and development of expert systems. From 1994 until 2001 he has worked as a senior scientific researcher at the Institute for production technologies GINTEC in Singapore, where he was also teaching at the postgraduate studies at the University of Technical Science in Singapore (courses: Concurrent Engineering and Data bases).



From January 25, 2001 until March 3, 2003 he was the Minister for Science, Technology and Development of the Republic of Serbia. After that, he worked as a professor at Faculty of Mechanical Engineering in Niš and at Faculty of Information Technologies which he has founded and whose dean he is. During that period he was the manager of one scientific-research project financed by the Ministry of Science and Environment Protection and participants. He was a mentor in the development of several doctoral thesis. During one mandate time he was elected the Chairman of the Department for Production, IT and Management at Faculty of Mechanical Engineering in Niš. In 2004 he was elected a corresponding member of Engineering Academy of Serbia and Montenegro. He speaks English and French. During 35 years of his scientific career Dragan Domazet has been working on the development of methods to support the integral development of new products. In his creative opus he included various aspects of the problem of integrated product design and his scientific work was focused on the following scientific topics: a) Static and dynamic analysis of the supporting structure of machine tools, (b) Analysis of drive systems of mechanical hydraulic presses, (c) Computer aided design of products and technologies of their production by applying of features and expert systems, (d) Methods of collaborative product development under conditions of heterogeneous computer systems.

In his work in Singapore Dragan Domazet has directed his research towards solving problems in heterogeneous computing environments and conditions, so he especially worked on the problems of setting up of integrated product models and the development of object-oriented product database based on STEP standards, development of proactive product databases that automatically respond to the events in the development environment in which they are located, application of collaborative agents; he has defined the so-called business objects that automatically monitor and direct the flow of the design process i.e. sequence of activities in accordance with the registered events and defined rules that determine the conditions for carrying out certain activities of the process. He worked on the development of the collaborative portal platform which enables engineers to work together through the internet, regardless of their location. Also, besides providing information services and product data, methodology for engineers knowledge management and for presentation and archiving of that knowledge has been specially developed.

Professional work of Dragan Domazet has followed his scientific career, so he has been implementing most of his research results in engineering practice. During the time when he was engaged in analysis of supporting structures of presses, computer and experimental analysis of the drive systems of mechanical and hydraulic presses, he has actively participated in the development of several different types of presses for certain press producers. Besides the development and application of the finite element method, a computer aided system for product and technologies design (CAD/CAPP/CAM), system for mechanism analysis PAM etc., Dragan Domazet has provided consulting services in the industry of Singapore in order to transfer and apply the most advanced manufacturing and information technologies. In his professional career, he has worked constantly on solving problems in industry, either working part-time (1978-1990 EI Niš) or working on industrial projects in Serbia and Singapore.

Velibor J. Marinković, Ph.D., full professor

E-mail: velmar@masfak.ni.ac.rs
Tel.: +381 (18) 500 626

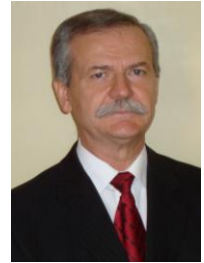

Personal data

- Prof. Velibor J. Marinković was born in Krezbinac, Paraćin, Serbia
- Graduated at the Faculty of Mechanical Engineering in Niš in 1971
- Finished his postgraduate studies at the Faculty of Mechanical Engineering in Niš in 1978
- Got his Ph.D. at the Faculty of Mechanical Engineering in Niš in 1982

Courses

Bachelor/master studies

- Manufacturing technologies
- Tools and devices
- Modeling and optimization of manufacturing processes
- Applied theory of plasticity

Doctoral studies

- Modeling and optimization of processes
- Theory of experimental design
- Tribology of manufacturing systems and processes

Field of scientific work

- Forming and shaping technologies
- Design of experiments and metrology
- Modeling and optimization of manufacturing processes

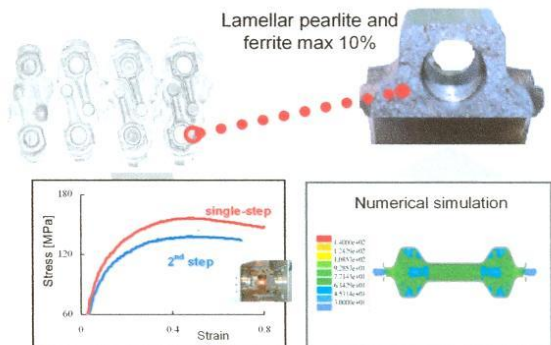

Selected published scientific papers

- Marinković V., Analysis of the process of the reversible and combined deep drawing, **Journal for Technology of Plasticity**, Vol. 18, 1993, No. 1-2, pp. 39-50.
- Marinković V., Application of some non-linear mathematical models to the theory of experimental design, **The scientific journal FACTA UNIVERSITATES, Series: Mechanical Engineering**, Vol. 1, 1994, No. 1, pp. 103-117.
- Marinković V., Stempelkraft naerungswise berechnen beim Napfrueckwaerts – fließpressen, **Maschinenmarkt**, Vol. 101, No 19,1995, s. 30-33.
- Marinković V., Janković Lj., Automated design of the multi-layer deep drawing process of the conical parts with the flange, **Journal for Technology of Plasticity**, Vol. 23, 1999, No. 1-2, pp. 87-94.
- Marinković V., Marinković T., Mechanical and structural properties of the extruded hollow profiles of Al-alloys. **Journal of Metallurgy**, Vol. 8, Iss. 4, 2002, pp. 301-308.
- Marinković V.: Automated choice of the optimal cutting regime in the peripheral milling process. **4th International Conference "Research and development in mechanical industry"-RaDMI 2004**, Zlatibor, 2004, pp. 221-227.
- Marinković V., Application of Artificial Neural Network for Modeling the Flash Land Dimensions in the Forging Dies. **Journal of Mechanical Engineering**. Vol. 55, No 1, 2009, pp. 64-75.
- Marinković V., Madić M., Optimization of surface roughness in turning alloy steel by using Taguchi method. **Scientific Research and Essays**, Vol. 6, Iss. 16, 2011, pp. 3474-3484.
- Marinković V.: Prediction of flow stress of alloyed steel in hot forming by applying different mathematical models and design of experiment. **Journal for Technology of Plasticity**, Vol. 36, No. 2, 2011, pp. 71-86.
- Tanikić D., Marinković V., Modelling and optimization of the surface roughness in the dry turning of the cold rolled alloyed steel using regression analysis, **Journal of the Braz. Society of Mech. Sciences and Engineering**, Vol. 33, No 1, 2012, pp.41-48.

Miodrag M. Stojilković, Ph.D., full professor
E-mail: misa@masfak.ni.ac.rs

Tel.: +381 (18) 500 624

**Personal data**

- Prof. Miodrag M. Stojilković was born in Niš, Serbia
- Graduated at the Faculty of Mechanical Engineering in Niš in 1969
- Finished his postgraduate studies at the Faculty of Mechanical Engineering in Niš in 1981
- Got his Ph.D. at the Faculty of Mechanical Engineering in Niš in 1986
- He is employed at the Faculty of Mechanical Engineering in Niš since 1975

Courses

Bachelor/master studies

- Flexible production systems
- Production automation
- Digital control systems
- Assembly technology
- Packing and paletisation

Doctoral studies

- Logic synthesis of digital systems
- Industrial automation
- Flexible automation

Field of scientific work

- Synthesis of FSM
- Automation of production processes
- Technology of assembly and packing

Selected published scientific papers

- Stojilković M., Rančić M., Theory of graphs and some possibilities of finite automates optimization, **FACTA UNIVERSITATES, Series: Mechanical Engineering**, Vo1, No 4, 1997, pp. 491 – 496.
 - Stojilković M., Rančić M., Automatizacija procesa prosejavanja i pakovanja mlevenog materijala, **12. Kongres PROCESING'98**, Bečići, **Procesna tehnika** br.2-3/1998, pp 31-33.
 - Stojilković M., Blagojević V., Presentation of a variant solution of the pneumatic system for realizing the ternary state, **FACTA UNIVERSITATES, Series: Mechanical Engineering**, Vo1. 1, No 6, 1999, pp. 735-742.
 - Stojilković M., Blagojević V., The NAIS Method for FASAT Pneumatics Based Sinthesis, **6. Simpozijum YU INFO 2000**, Kopaonik, 2000, (CD).
 - Blagojević V., Stojilković M., The expert system for computer-aided investigation of principal pneumatic diagrams of combinatory automates, **FACTA UNIVERSITATES, Series: Mechanical Engineering**, Vo1. 1, No 8, 2001, pp. 1049-1056.
 - Stojilković M., Blagojević V., Mogućnosti reinženjeringa upravljačkih sistema u automatizaciji proizvodnje, **Ekonomске teme**, Niš, 2003, str. 47-56.
 - Blagojević V., Milosavljević Č., Stojilković M., Advantages of digital position control with sliding mode of the double acting pneumatic cylinder, **Scientific Conference MANUFACTURING AND MANAGEMENT IN 21ST CENTURY**, Ohrid, 2004, pp. 190-195.
 - Stojilković M., Šešlija D., Blagojević V., HIPNEF technologies in the technological processes automation, **Inter. Scientific Conf. UNITECH'04**, Gabrovo, 2004, str. II-215-220.
 - Blagojević V., Stojilković M., Dynamic Model of the Pneumatic actuator system, **Theoretical and Experimental Research of Elasto – Plastic Behaviour of Engineering Structures**, University of Niš, Niš, Serbia, 2006, pp. 261-266.
 - Blagojević V., Šešlija D., Stojilković M., Cost effectiveness of restoring energy in execution part of pneumatic system, **Journal of Scientific & Industrial Research**, Vol 70., No2, February 2011, pp. 170-176.
-

UNIVERSITY OF NIŠ
FACULTY OF MECHANICAL ENGINEERING
Aleksandra Medvedeva 14
18000 Niš

tel.: +381 18 500 662
fax: +381 18 500 660
e-mail: traja@masfak.ni.ac.rs
web: <http://www.masfak.ni.ac.rs>